

Areamaster™ Generation 2 LED Luminaire Floodlight for Hazardous Locations

NEC/CEC:

Class I, Division 2, Groups A, B, C, D
Class I, Zone 2 Group IIC
Class II, Division 1 and 2, Groups E, F, G
Class III
Zone 20 and 21 Group IIIC

NEC/CEC:

Zone 22, Group IIIB
Simultaneous Exposure
Marine Outside Type (Salt Water) for USA ONLY
Wet Locations
Type 3R, 4, 4X, IP66/67

ATEX/IECEX:

Zone 2 and 22
IP66
II 3GD
IK10
Ex ec IIC T5

Applications

- Enclosed and gasketed fixtures suitable for use in:
 - A wide range of industrial, chemical processing and other areas where flammable gases and vapors are present, for example
 - Oil and Gas Refineries
 - Petrochemical Plants
 - Foundries
 - Drilling Rigs
 - Pulp and Paper Mills
 - Food and Beverage Processing Facilities
 - Loading Docks
 - Power Plants
 - Water and Wastewater Treatment Facilities
 - Other areas where corrosive, wet, dirty and tough environments are a problem
- IP66/IP67, Type 4X, marine and wet locations
- Locations requiring dependable, consistent lighting in extreme hot/cold temperature environments. -40°C to +65°C (-40°F to +149°F) ambient temperature range

Features

- Three lumen outputs provide up to 19,500 lumens.

Nominal Lumens ①	Wattage (W)	Efficacy (lpw)	HID Equivalent	Model Number
9,500	70	136	175W-250W	AMLGL6
15,000	110	136	250W-400W	AMLGL7
19,500	150	130	400W-750W	AMLGL8

① Nominal lumen value for 5000K, detailed lumen information provided in tables.

- Choice of optics for optimal light distribution in a variety of applications.
- Separate field wiring compartment with screw terminal block for easy and secure connection (can accept UL/CSA 26-10AWG).
- Two 3/4" NPT entries provided.
- Yoke bracket is designed to accommodate traditional Areamaster brackets and slipfitters for easy retrofit.
- Choice of color temperature (CCT); 5000K cool white or 3000K warm white.
- Rugged and compact housing with superior thermal design translates to long luminaire life.
- Heavy duty, high temperature silicone rubber gaskets.
- Thermal shock and impact resistant clear or frosted glass lens.
- Standard 6KV surge protection.
- Captive fasteners secure one piece lens.
- Field replaceable LED driver and lens cover.

Options

- Improved safety cable design with multiple retention points, purchase separately
- Guard and visor available, purchase separately
- Slip-fitters and mounting brackets available for easy pole or wall mounting
- 10KV Surge Protection



Standard Materials

- Housing and lens door: copperfree (4/10 of 1% max.) aluminum
- Gaskets: silicone rubber
- Yoke: zinc plated HR steel
- Bolts: stainless steel
- Close up plugs: (1) aluminum provided
- Guard and safety cable: stainless steel
- Visor: Aluminum

Standard Finishes

- Housing, lens cover, visor and yoke mount: architectural bronze polyester

Related Products

- Round Tapered Steel Poles
- Hinged Steel Poled
- Square Tapered Steel Poles
- Square Steel Poles
- Floodlight Mounting Brackets

NEC/CEC Certifications and Compliances

- UL Standards:
 - UL844, Luminaires for Use in Hazardous Locations
 - UL1598, Luminaires
 - UL1598A, Luminaires for Installation on Marine Vessels
 - UL 8750, LED Equipment for Use in Lighting Products
- CSA Standards:
 - CSA C22.2 No. 250.0, Luminaires
 - CSA C22.2 No. 137, Luminaires for Use in Hazardous Locations
- cCSAus: 164460, Certificate Number: 70073611

APPLETON™

LED/FLOODLIGHTS: NEC/CEC, ATEX/IECEX ENCLOSED AND GASKETED

Areamaster™ Generation 2 LED Luminaire

Floodlight for Hazardous Locations

NEC/CEC:

Class I, Division 2, Groups A, B, C, D
 Class I, Zone 2 Group IIC
 Class II, Division 1 and 2, Groups E, F, G
 Class III
 Zone 20 and 21 Group IIIC

NEC/CEC:

Zone 22, Group IIIB
 Simultaneous Exposure
 Marine Outside Type (Salt Water) for USA ONLY
 Wet Locations
 Type 3R, 4, 4X, IP66/67

ATEX/IECEX:

Zone 2 and 22
 IP66
 II 3GD
 IK10
 Ex ec IIC T5

ATEX/IECEX Certifications and Compliances

- Certification Type: Areamaster Gen 2
 - Gas: Zone 2
 - Conforming to ATEX 2014/34/EU: II 3 G
 - Type of Protection: Ex ec IIC Gc
 - Temperature Class: T5 to T3
 - Dust: Zone 22
 - Conforming to ATEX 2014/34/EU: II 3 D
 - Type of Protection: Ex tc IIIC Dc
 - Surface Temperature: +85°C to +100°C (+185°F to +212°F)
- Ambient Temperature: -40°C up to +65°C (-40°F up to +268°F)
- EU Declaration of Conformity: 50317
- ATEX Certificate: SIRA 17ATEX3241
- IECEX Certificate: IECEX SIR 17.0079
- Index of Protection according EN/IEC 60529: IP66
- Impact Resistance (shock): IK10
- Photobiological Safety, IEC 62778 and IEC 62471: RG0

DesignLights™ Consortium (for the following models)

- All models pending.

Order using catalog numbering guides below or select catalog number from tables on following pages.

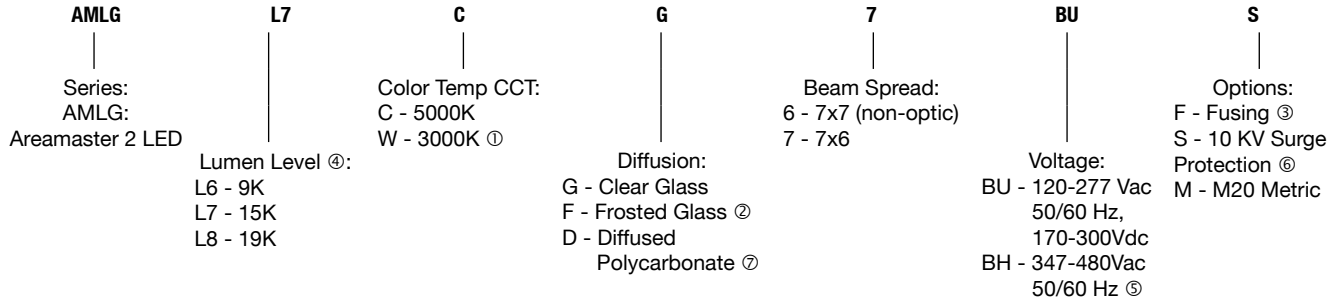

Lumen Output Tables ④:

Lumen Output for Clear Glass Lens			
	AMLGL6	AMLGL7	AMLGL8
NEMA 7x7 (Non Optic), 5000K CCT, CRI 70	9,900	15,300	19,900
NEMA 7x6, 3000K CCT, CRI 80	8,100	11,900	15,500
NEMA 7x6, 5000K CCT, CRI 70	9,000	14,200	18,400

Lumen Output for Frosted Glass Lens			
	AMLGL6	AMLGL7	AMLGL8
NEMA 7x7 (Non Optic), 5000K CCT	8,000	12,600	16,300

① 3000K CCT (warm) is not available with NEMA 7x7 light pattern
 ② Frosted Glass is only available with NEMA 7x7 light pattern
 ③ Use of fuse voids Marine rating. Fusing not available for NEC/CEC.
 ④ All lumen values are typical (tolerance +/-10%).
 ⑤ BH voltage available for NEC/CEC only.
 ⑥ 10 kV Surge Protection available for NEC/CEC only.
 ⑦ Diffused polycarbonate available for NEC/CEC only.

APPLETON™

LED/FLOODLIGHTS: NEC/CEC, ATEX/IECEX ENCLOSED AND GASKETED

Areamaster™ Generation 2 LED Luminaire

Floodlight for Hazardous Locations

NEC/CEC:

Class I, Division 2, Groups A, B, C, D
 Class I, Zone 2 Group IIC
 Class II, Division 1 and 2, Groups E, F, G
 Class III
 Zone 20 and 21 Group IIIC

NEC/CEC:



Zone 22, Group IIIB
 Simultaneous Exposure
 Marine Outside Type (Salt Water) for USA ONLY
 Wet Locations
 Type 3R, 4, 4X, IP66/67

ATEX/IECEX:

Zone 2 and 22
 IP66
 II 3GD
 IK10
 Ex ec IIC T5

Electrical Ratings ①

Voltage Suffix	Voltage (V)	Input Power (Watts)	Input Current (Amps)	Power Factor (PF)	Total Harmonic Distortion (THD)	Model Number	
BU	120 Vac	73	0.62	>.9	<20%	AMLGL6	
	277 Vac	71	0.27				
	170 Vdc	69	0.41	N/A	N/A		
	300 Vdc	68	0.23				
BH	347 Vac	71	0.21	>.9	<20%		
	480 Vac	71	0.16				
BU	120 Vac	111	0.94	>.9	<20%		AMLGL7
	277 Vac	106	0.43				
	170 Vdc	113	0.67	N/A	N/A		
	300 Vdc	111	0.37				
BH	347 Vac	115	0.33	>.9	<20%		
	480 Vac	115	0.25				
BU	120 Vac	154	1.30	>.9	<20%	AMLGL8	
	277 Vac	146	0.56				
	170 Vdc	156	0.92	N/A	N/A		
	300 Vdc	152	0.51				
BH	347 Vac	150	0.43	>.9	<20%		
	480 Vac	149	0.32				

Luminaire Category	Image	Frontal Projected Area (FPA) ft ²	Drag Coefficient (DC)	Effective Projected Area (EPA) = FPA*DC ft ²
90° to Ground-Worst Case Mounting		1.52	1.20	1.82
45° to Ground-Standard Mounting		1.07	1.2	1.28

Surge Protection: Integral 6KV surge protection. Option for up to 10KV surge protection. (cCSAus only).

① All ratings are typical.

APPLETON™

LED/FLOODLIGHTS: NEC/CEC, ATEX/IECEX ENCLOSED AND GASKETED

Areamaster™ Generation 2 LED Luminaire

Floodlight for Hazardous Locations

NEC/CEC:

Class I, Division 2, Groups A, B, C, D
 Class I, Zone 2 Group IIC
 Class II, Division 1 and 2, Groups E, F, G
 Class III
 Zone 20 and 21 Group IIIC

NEC/CEC:

Zone 22, Group IIIB
 Simultaneous Exposure
 Marine Outside Type (Salt Water) for USA ONLY
 Wet Locations
 Type 3R, 4, 4X, IP66/67

ATEX/IECEx:

Zone 2 and 22
 IP66
 II 3GD
 IK10
 Ex ec IIC T5

NEC/CEC Temperature Codes

Lamp Line Voltage	Ambient Temperature °C (°F)	Supply Wire Temperature °C (°F)	Gas		Dust		Class I Division 2 and Class 2 Division I	Model Number
			Class I, Division 2 ① Groups A, B, C, D	Class I, Zone 2 Group IIC	Class II, Division 1 Groups E,F,G	Zone 20, Group IIIC		
120-277 Vac/ 170-300 Vdc; 347-480 Vac	40 (104)	90 (194)	T5	T5	T6	T6	T4A	AMLGL6
	55 (131)	90 (194)	T4A	T4	T6	T6	T4A	
	65 (149)	90 (194)	T4A	T4	T6	T6	T4	
120-277 Vac/ 170-300 Vdc; 347-480 Vac	40 (104)	90 (194)	T4A	T4	T6	T6	T4	AMLGL7
	55 (131)	90 (194)	T3C	T3	T6	T6	T3C	
	65 (149)	90 (194)	T3C	T3	T5	T5	T3C	
120-277 Vac/ 170-300 Vdc; 347-480 Vac	40 (104)	90 (194)	T3C	T3	T6	T6	T3C	AMLGL8
	55 (131)	90 (194)	T3B	T3	T5	T5	T3A	
	65 (149)	90 (194)	T3A	T3	T5	T5	T3A	

ATEX/IECEx Temperature Codes

Gas			Dust				Model Number
T Rating			Surface Temperature				
Ta= +40 °C (+104 °F)	Ta= +55 °C (+131 °F)	Ta= +65 °C (+149 °F)	Ta= +40 °C (+104 °F)	Ta= +55 °C (+131 °F)	Ta= +65 °C (+149 °F)		
T5	T4	T4	T85°C	T85°C	T85°C		AMLGL6
T4	T3	T3	T85°C	T85°C	T100°C		AMLGL7
T3	T3	T3	T85°C	T100°C	T100°C		AMLGL8

“T” Numbers Represent the Maximum Internal Temperature ① or Maximum Surface Temperature ②

“T” #	NEC/CEC															
	T1	350	325	T2	T2A	T2B	T2C	T2D	T3	T3A	T3B	T3C	T4	T4A	T5	T6
Temp. Range °C (°F)	351-450 (664-842)	326-350 (619-662)	301-325 (574-617)	281-300 (538-572)	261-280 (502-536)	231-260 (448-500)	216-230 (421-446)	201-215 (394-419)	181-200 (358-392)	166-180 (331-356)	161-165 (322-329)	136-160 (277-320)	121-135 (250-275)	101-120 (214-248)	86-100 (187-212)	85 (185)
“T” #	ATEX/IECEx															
	T1	T2				T3				T4		T5	T6			
Temp. Range °C (°F)	301-450 (547-842)	201-300 (394-572)				136-200 (277-392)				101-135 (214-275)		86-100 (187-212)	85 (185)			

① T numbers represent the maximum internal temperature for Class I, Division 2 and Class I, Zone 2 locations designated by the NEC.

② T numbers represent the maximum surface temperature under a dust blanket for Class II, Division 1 and 2 as designated by the NEC.

Areamaster™ Generation 2 LED Luminaire

Floodlight for Hazardous Locations

NEC/CEC:



Class I, Division 2, Groups A, B, C, D
 Class I, Zone 2 Group IIC
 Class II, Division 1 and 2, Groups E, F, G
 Class III
 Zone 20 and 21 Group IIIC

NEC/CEC:

Zone 22, Group IIIB
 Simultaneous Exposure
 Marine Outside Type (Salt Water) for USA ONLY
 Wet Locations
 Type 3R, 4, 4X, IP66/67

ATEX/IECEX:

Zone 2 and 22
 IP66
 II 3GD
 IK10
 Ex ec IIC T5

	CCT	Lumen Output	Wattage	Efficacy (lm/W)	Optical Pattern	Catalog Number ①
Clear Glass						
	120-277 Vac/170-300 Vdc					
	5000K (cool white)	9900	70	141	NEMA 7x7 (150°x150°)	AMLGL6CG6BU
	5000K (cool white)	9000	70	129	NEMA 7x6 (136°x113°)	AMLGL6CG7BU
	3000K (warm white)	8100	70	116	NEMA 7x6 (136°x113°)	AMLGL6WG7BU
	5000K (cool white)	15300	111	138	NEMA 7x7 (150°x150°)	AMLGL7CG6BU
	5000K (cool white)	14200	111	128	NEMA 7x6 (136°x113°)	AMLGL7CG7BU
	3000K (warm white)	11900	111	107	NEMA 7x6 (136°x113°)	AMLGL7WG7BU
	5000K (cool white)	19900	158	126	NEMA 7x7 (150°x150°)	AMLGL8CG6BU
	5000K (cool white)	18400	158	116	NEMA 7x6 (136°x113°)	AMLGL8CG7BU
	3000K (warm white)	15500	158	98	NEMA 7x6 (136°x113°)	AMLGL8WG7BU
	347-480 Vac					
	5000K (cool white)	9900	71	139	NEMA 7x7 (150°x150°)	AMLGL6CG6BH
	5000K (cool white)	9000	71	127	NEMA 7x6 (136°x113°)	AMLGL6CG7BH
	3000K (warm white)	8100	71	114	NEMA 7x6 (136°x113°)	AMLGL6WG7BH
	5000K (cool white)	15300	115	133	NEMA 7x7 (150°x150°)	AMLGL7CG6BH
	5000K (cool white)	14200	115	123	NEMA 7x6 (136°x113°)	AMLGL7CG7BH
	3000K (warm white)	11900	109	109	NEMA 7x6 (136°x113°)	AMLGL7WG7BH
	5000K (cool white)	19900	157	127	NEMA 7x7 (150°x150°)	AMLGL8CG6BH
	5000K (cool white)	18400	157	117	NEMA 7x6 (136°x113°)	AMLGL8CG7BH
	3000K (warm white)	15500	150	103	NEMA 7x6 (136°x113°)	AMLGL8WG7BH
Frosted Glass						
	120-277 Vac/170-300 Vdc					
	5000K (cool white)	8100	70	116	NEMA 7x7 (150°x150°)	AMLGL6CF6BU
	5000K (cool white)	12700	111	114	NEMA 7x7 (150°x150°)	AMLGL7CF6BU
	5000K (cool white)	16500	158	104	NEMA 7x7 (150°x150°)	AMLGL8CF6BU
	347-480 Vac					
	5000K (cool white)	8100	71	114	NEMA 7x7 (150°x150°)	AMLGL6CF6BH
5000K (cool white)	12700	115	110	NEMA 7x7 (150°x150°)	AMLGL7CF6BH	
5000K (cool white)	16500	157	105	NEMA 7x7 (150x150)	AMLGL8CF6BH	

① For Fusing option, add suffix **F** to end of part number, example AMLGL8CG6BUF.
 For 10KV surge protection, add suffix **S** to end of part number, example AMLGL7CG7BUS.
 For both Fusing and 10KV surge, add suffix **FS** to end of part number, example AMLGL8CG7BUFS.

Areamaster™ Generation 2 LED Luminaire

Floodlight for Hazardous Locations

NEC/CEC:

Class I, Division 2, Groups A, B, C, D
 Class I, Zone 2 Group IIC
 Class II, Division 1 and 2, Groups E, F, G
 Class III
 Zone 20 and 21 Group IIIC

NEC/CEC:

Zone 22, Group IIIB
 Simultaneous Exposure
 Marine Outside Type (Salt Water) for USA ONLY
 Wet Locations
 Type 3R, 4, 4X, IP66/67

ATEX/IECEX:

Zone 2 and 22
 IP66
 II 3GD
 IK10
 Ex ec IIC T5

Accessories and Replacement Parts

	Description	Catalog Number
Crossarm Mounting Bracket		
	Has 180° horizontal adjustment — degree marked. Facilitates mounting floodlight to crossarm or other flat surface, or to G-AM-8-WB. Includes floodlight yoke bolts. Malleable iron, zinc plated, chromate sealed, architectural bronze polyester finish.	G-AM-8-CA
Pipe or Wall Mount Bracket		
	Used with G-AM-8-CA. Clamps to 1" to 2-1/2" pipe, vertical or horizontal, or mounts on flat surfaces. Includes U-bolt and crossarm bracket bolts. Malleable iron, zinc plated, chromate sealed, with architectural bronze polyester finish.	G-AM-8-WB
		
Crossarm Mounting Bracket (G-AM-8-CA) used with Pipe or Wall Mount Bracket (G-AM-8-WB).		
Poletop Slip-Fitter		
	Slip-fits 1-1/2" or 2" pipe size poletop tenons. Includes floodlight yoke bolts, 3 locking bolts, and cord grip. Body is malleable iron-zinc plated, chromate sealed, with cast aluminum cap. Assembly has architectural bronze polyester finish.	G-SF20
	Slip-fits 1" or 1-1/2" pipe size poletop tenons. Includes floodlight yoke bolts, 3 locking bolts, and cord grip. Body is malleable iron-zinc plated, chromate sealed, with cast aluminum cap. Assembly has architectural bronze polyester finish.	AMLEDSF1
Poletop Slip-Fitter		
	Slip-fits 2" or 2-1/2" poletop tenons. Includes floodlight yoke bolts, 3 locking bolts, and cord grip. Malleable iron, zinc plated, chromate sealed, with architectural bronze polyester finish.	G-AM-8-SF

APPLETON™

LED/FLOODLIGHTS: NEC/CEC, ATEX/IECEX ENCLOSED AND GASKETED

Areamaster™ Generation 2 LED Luminaire

Floodlight for Hazardous Locations

NEC/CEC:

Class I, Division 2, Groups A, B, C, D
 Class I, Zone 2 Group IIC
 Class II, Division 1 and 2, Groups E, F, G
 Class III
 Zone 20 and 21 Group IIIC





NEC/CEC:

Zone 22, Group IIIB
 Simultaneous Exposure
 Marine Outside Type (Salt Water) for USA ONLY
 Wet Locations
 Type 3R, 4, 4X, IP66/67

ATEX/IECEX:

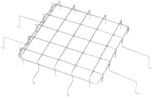
Zone 2 and 22
 IP66
 II 3GD
 IK10
 Ex ec IIC T5

Accessories and Replacement Parts

	Description	Catalog Number
Wall Mount Bracket		
	Used with G-AM-8-SF and GSF-20 to provide a wall mounting option. Galvanized Steel.	GPSWB6GAL
Wire Guard		
	Stainless steel.	LGGUARD
Safety Cable		
	Stainless steel.	LEDSC
Visor		
	Steel with architectural bronze polyester finish. For Dark Sky Friendly design.	AMLGV
Portable Floodlight Base		
	Portable floodlight base for temporary lighting applications. To be used with wire guard. Malleable iron with architectural bronze polyester finish.	G-AM-PFB
Replacement Covers		
		AMLGCLEAR AMLGFROST

Areamaster™ Generation 2 LED Luminaire

Floodlight for Hazardous Locations

NEC/CEC:

Class I, Division 2, Groups A, B, C, D
 Class I, Zone 2 Group IIC
 Class II, Division 1 and 2, Groups E, F, G
 Class III
 Zone 20 and 21 Group IIIC



NEC/CEC:

Zone 22, Group IIIB
 Simultaneous Exposure
 Marine Outside Type (Salt Water) for USA ONLY
 Wet Locations
 Type 3R, 4, 4X, IP66/67

ATEX/IECEX:

Zone 2 and 22
 IP66
 II 3GD
 IK10
 Ex ec IIC T5

Replacement Drivers

	Voltage	Driver Wattage	Constant Current Setting	Luminaire Model	CCT	Catalog Number
	BU	100 watt	410mA	AMLGL6C, AMLGL6W	5K and 3K	APMS100C105UD41
	BH					APMS100C105HD41
	BU	150 watt	650mA	AMLGL7W	3K	APMS150C105UD65
	BH					APMS150C105HD65
	BU	150 watt	680mA	AMLGL7C	5k	APMS150C105UD68
	BH					APMS150C105HD68
	BU	150 watt	890mA	AMLGL8W	3K	APMS150C105UD89
	BH					APMS150C105HD89
	BU	150 watt	930mA	AMLGL8C	5k	APMS150C105UD93
	BH					APMS150C105HD93

Areamaster Generation 2 Accessory Weights

Description	Weight in kg (lbs)
AMLGL6, AMLGL7, AMLGL8 Luminaires	9.8 (21.6)
Yoke Bracket	1.41 (3.1)
Visor	0.2 (0.4)
Guard	0.2 (0.4)
Safety Cable	0.2 (0.4)
Crossarm Mounting Bracket G-AM-8-CA	1.4 (3.1)
Pipe or Wall Mount Bracket G-AM-8-WB	2.9 (6.4)
Poletop Slip-Fitter GSF20	1.4 (3.1)
Poletop Slip-Fitter AMLEDSF1	2.4 (5.3)
Poletop Slip-Fitter GAM8SF	—
—	—

APPLETON™

LED/FLOODLIGHTS: NEC/CEC, ATEX/IECEX ENCLOSED AND GASKETED

Areamaster™ Generation 2 LED Luminaire Floodlight for Hazardous Locations

NEC/CEC:

Class I, Division 2, Groups A, B, C, D
Class I, Zone 2 Group IIC
Class II, Division 1 and 2, Groups E, F, G
Class III
Zone 20 and 21 Group IIIC

NEC/CEC:

Zone 22, Group IIIB
Simultaneous Exposure
Marine Outside Type (Salt Water) for USA ONLY
Wet Locations
Type 3R, 4, 4X, IP66/67

ATEX/IECEX:

Zone 2 and 22
IP66
II 3GD
IK10
Ex ec IIC T5

Dimensions in Millimeters (Inches)

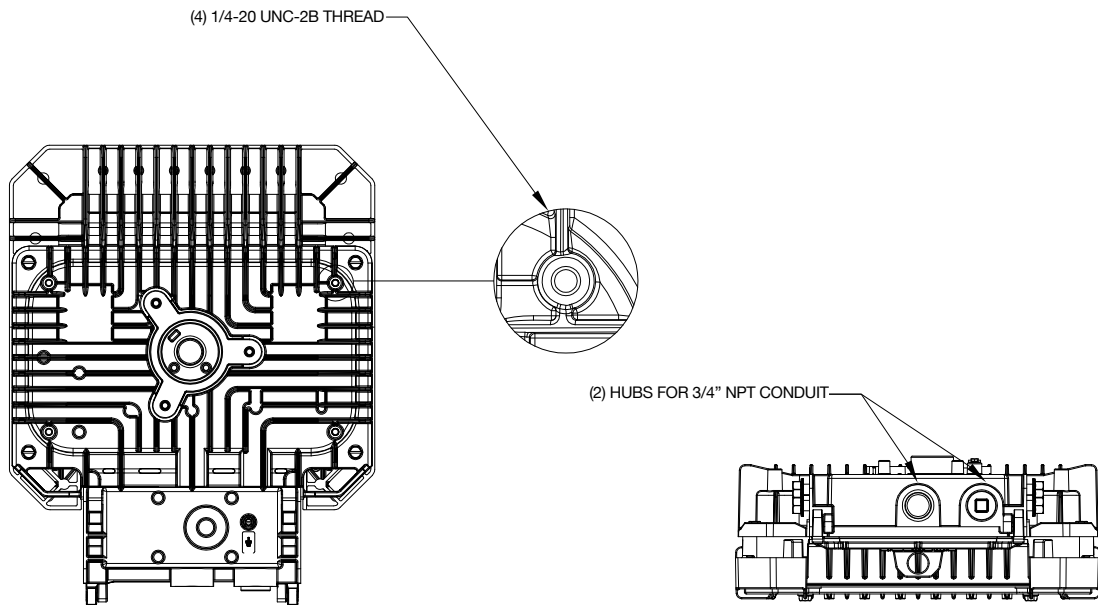
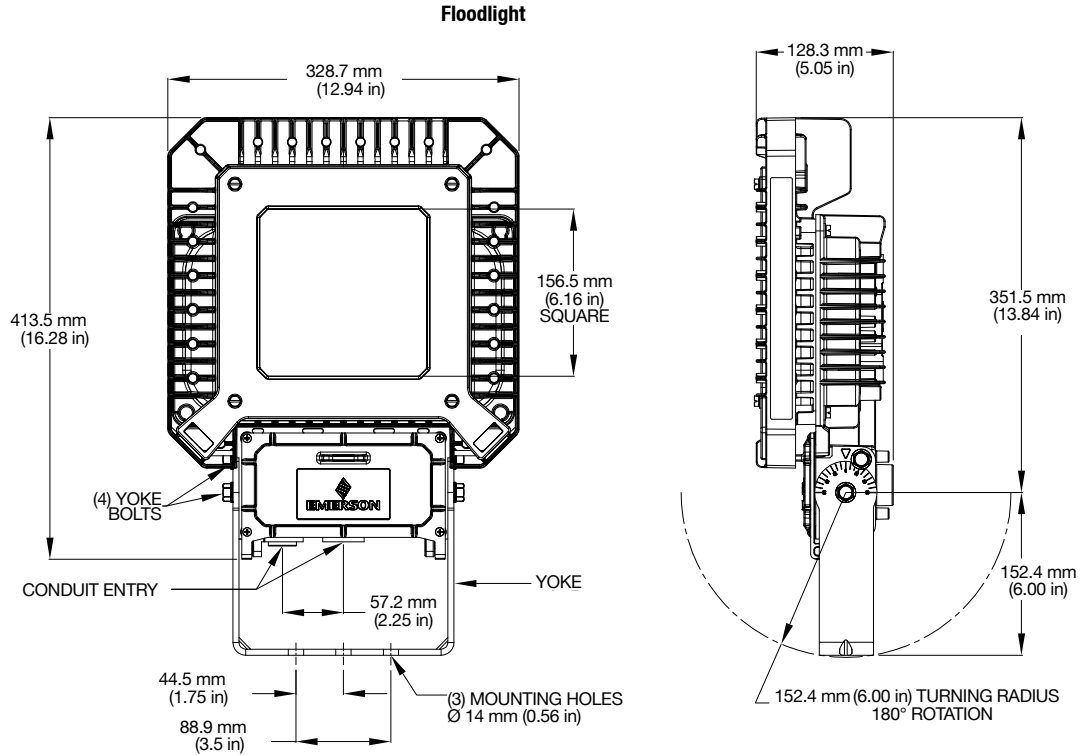

APPLETON™

LED/FLOODLIGHTS: NEC/CEC, ATEX/IECEX ENCLOSED AND GASKETED

Areamaster™ Generation 2 LED Luminaire

Floodlight for Hazardous Locations

NEC/CEC:

Class I, Division 2, Groups A, B, C, D
 Class I, Zone 2 Group IIC
 Class II, Division 1 and 2, Groups E, F, G
 Class III
 Zone 20 and 21 Group IIIC

NEC/CEC:

Zone 22, Group IIIB
 Simultaneous Exposure
 Marine Outside Type (Salt Water) for USA ONLY
 Wet Locations
 Type 3R, 4, 4X, IP66/67

ATEX/IECEX:

Zone 2 and 22
 IP66
 II 3GD
 IK10
 Ex ec IIC T5

Photometric Data – DATA SHOWN IS ABSOLUTE

NEMA 7x7, Clear Glass

REPORT NUMBER: **AMLGL6CG6BU**

Luminaire Lumens 9,964

POLAR CANDELA DISTRIBUTION

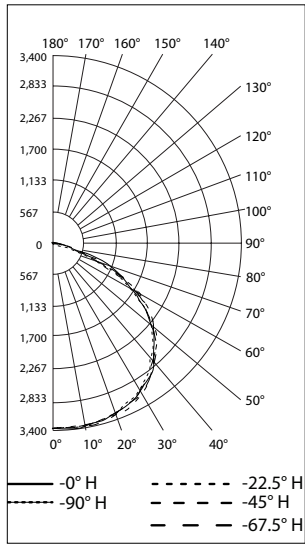

ISOFOOT CANDLE PLOT AT 45°

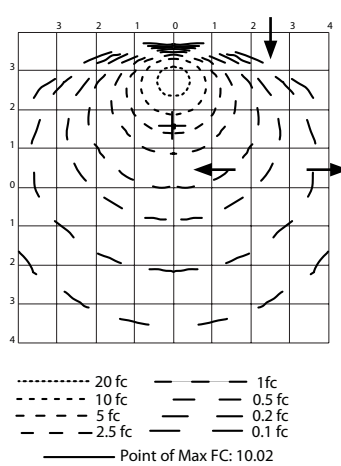

FLOOD SUMMARY

	Efficiency	Lumens	Horizontal Spread	Vertical Spread
Field (10%)	98.5%	9,817.4	150	148
Beam (50%)	82.2%	8,196.6	117.3	116.2
Total	100%	9,964.0		

Tilt Angle– 45 Degree LLF–0.9

Mounting Height m (ft)	Maximum Point (fc)	Forward Throw Distance			
		0.5fc/5lx m (ft)	1fc/11lx m (ft)	2fc/22lx m (ft)	5fc/54lx m (ft)
6 (20)	1.51	14 (45)	11 (35)	7 (24)	3 (11)
9 (30)	0.68	14 (47)	11 (36)	6 (21)	—
12 (40)	0.38	15 (50)	11 (35)	—	—

Side-to-Side Distance

Mounting Height m (ft)	0.5fc/5lx m (ft)	1fc/11lx m (ft)	2fc/22lx m (ft)	5fc/54lx m (ft)
6 (20)	20 (66)	15 (50)	12 (38)	5 (16)
9 (30)	24 (78)	15 (50)	9 (28)	—
12 (40)	21 (70)	12 (40)	—	—

NEMA 7x7, Frosted Glass

REPORT NUMBER: **AMLGL6CF6BU**

Luminaire Lumens 8,115

POLAR CANDELA DISTRIBUTION

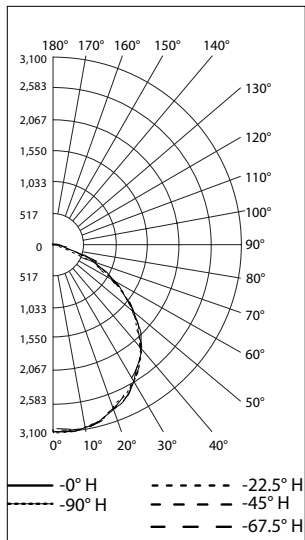

ISOFOOT CANDLE PLOT AT 45°

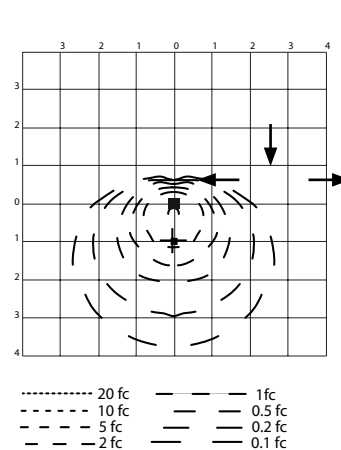

FLOOD SUMMARY

	Efficiency	Lumens	Horizontal Spread	Vertical Spread
Field (10%)	98.1%	7,961.7	155.3	151.5
Beam (50%)	71.5%	5,804.1	105.8	105.5
Total	100%	8,112.2		

Tilt Angle– 45 Degree LLF–0.9

Mounting Height m (ft)	Maximum Point (fc)	Forward Throw Distance			
		0.5fc/5lx m (ft)	1fc/11lx m (ft)	2fc/22lx m (ft)	5fc/54lx m (ft)
6 (20)	2.49	13 (42)	10 (33)	7 (24)	2 (8)
9 (30)	1.1	14 (45)	10 (32)	5 (15)	—
12 (40)	0.62	15 (48)	8 (25)	—	—

Side-to-Side Distance

Mounting Height m (ft)	0.5fc/5lx m (ft)	1fc/11lx m (ft)	2fc/22lx m (ft)	5fc/54lx m (ft)
6 (20)	18 (60)	13 (44)	9 (30)	1 (4)
9 (30)	20 (64)	10 (34)	6 (20)	—
12 (40)	17 (56)	9 (30)	—	—

APPLETON™

LED/FLOODLIGHTS: NEC/CEC, ATEX/IECEX ENCLOSED AND GASKETED

Areamaster™ Generation 2 LED Luminaire

Floodlight for Hazardous Locations

NEC/CEC:

Class I, Division 2, Groups A, B, C, D
 Class I, Zone 2 Group IIC
 Class II, Division 1 and 2, Groups E, F, G
 Class III
 Zone 20 and 21 Group IIIC

NEC/CEC:

Zone 22, Group IIIB
 Simultaneous Exposure
 Marine Outside Type (Salt Water) for USA ONLY
 Wet Locations
 Type 3R, 4, 4X, IP66/67

ATEX/IECEX:

Zone 2 and 22
 IP66
 II 3GD
 IK10
 Ex ec IIC T5

Photometric Data – DATA SHOWN IS ABSOLUTE

NEMA 7x7, Clear Glass

REPORT NUMBER: **AMLGL7CG6BU**

Luminaire Lumens 15,320

POLAR CANDELA DISTRIBUTION

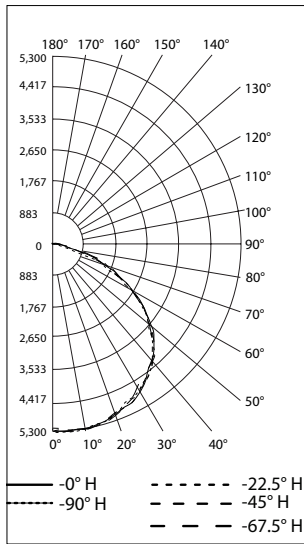

ISOFOOT CANDLE PLOT AT 45°

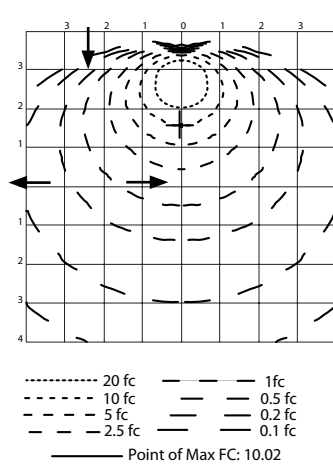

FLOOD SUMMARY

	Efficiency	Lumens	Horizontal Spread	Vertical Spread
Field (10%)	98.5%	15,102.6	151.2	147
Beam (50%)	81.9%	12,555.7	117	115.4
Total	100%	15,320.4		

Tilt Angle– 45 Degree LLF–0.9

Mounting Height m (ft)	Maximum Point (fc)	Forward Throw Distance			
		0.5fc/5lx m (ft)	1fc/11lx m (ft)	2fc/22lx m (ft)	5fc/54lx m (ft)
6 (20)	4.42	15 (50)	12 (39)	9 (29)	5 (16)
9 (30)	1.97	17 (55)	13 (43)	8 (25)	—
12 (40)	1.11	17 (57)	12 (40)	6 (19)	—

Mounting Height m (ft)	Side-to-Side Distance			
	0.5fc/5lx m (ft)	1fc/11lx m (ft)	2fc/22lx m (ft)	5fc/54lx m (ft)
6 (20)	21 (70)	56 (17)	12 (40)	6 (20)
9 (30)	24 (80)	58 (18)	12 (38)	—
12 (40)	24 (80)	50 (15)	5 (16)	—

NEMA 7x7, Frosted Glass

REPORT NUMBER: **AMLGL7CF6BU**

Luminaire Lumens 12,782

POLAR CANDELA DISTRIBUTION

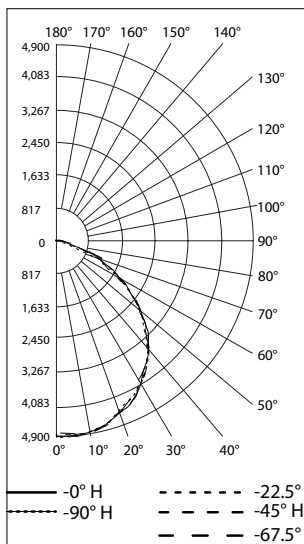

ISOFOOT CANDLE PLOT AT 45°

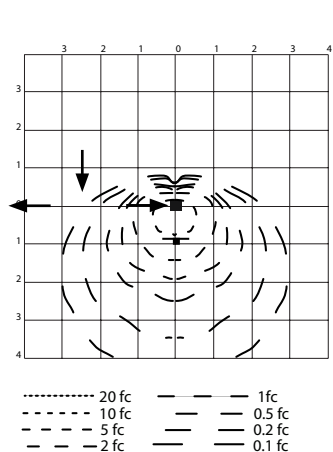

FLOOD SUMMARY

	Efficiency	Lumens	Horizontal Spread	Vertical Spread
Field (10%)	98.1%	12,536.1	155.4	150.7
Beam (50%)	71.3%	9,112.8	105.4	105.6
Total	100%	12,777.9		

Tilt Angle– 45 Degree LLF–0.9

Mounting Height m (ft)	Maximum Point (fc)	Forward Throw Distance			
		0.5fc/5lx m (ft)	1fc/11lx m (ft)	2fc/22lx m (ft)	5fc/54lx m (ft)
6 (20)	2.91	18 (59)	14 (45)	11 (35)	7 (22)
9 (30)	1.29	19 (63)	16 (51)	10 (33)	4 (12)
12 (40)	0.73	21 (70)	15 (50)	9 (30)	—

Mounting Height m (ft)	Side-to-Side Distance			
	0.5fc/5lx m (ft)	1fc/11lx m (ft)	2fc/22lx m (ft)	5fc/54lx m (ft)
6 (20)	26 (84)	21 (70)	16 (52)	10 (32)
9 (30)	29 (96)	22 (72)	16 (54)	5 (15)
12 (40)	32 (104)	22 (72)	15 (48)	—

Areamaster™ Generation 2 LED Luminaire Floodlight for Hazardous Locations

NEC/CEC:
Class I, Division 2, Groups A, B, C, D
Class I, Zone 2 Group IIC
Class II, Division 1 and 2, Groups E, F, G
Class III
Zone 20 and 21 Group IIIC

NEC/CEC:
Zone 22, Group IIIB
Simultaneous Exposure
Marine Outside Type (Salt Water) for USA ONLY
Wet Locations
Type 3R, 4, 4X, IP66/67

ATEX/IECEX:
Zone 2 and 22
IP66
II 3GD
IK10
Ex ec IIC T5

Photometric Data – DATA SHOWN IS ABSOLUTE

NEMA 7x7, Clear Glass
REPORT NUMBER: AMLGL8CG6BU

Luminaire Lumens 19,895

POLAR CANDELA DISTRIBUTION

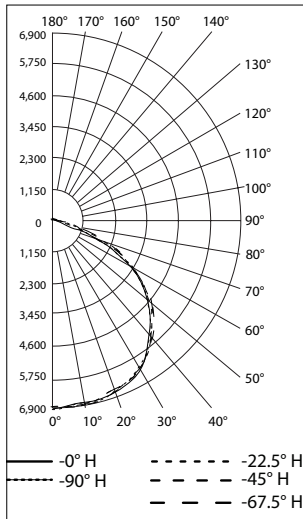

ISOFOOT CANDLE PLOT AT 45°

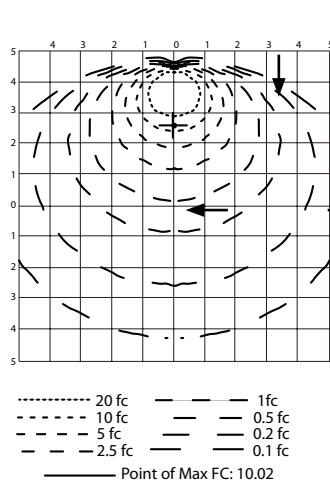

FLOOD SUMMARY

	Efficiency	Lumens	Horizontal Spread	Vertical Spread
Field (10%)	98.6%	19,614.8	151	146.8
Beam (50%)	81.7%	16,267.6	116.7	115.2
Total	100%	19,895.4		

Tilt Angle – 45 Degree LLF – 0.9

Mounting Height m (ft)	Maximum Point (fc)	Forward Throw Distance			
		0.5fc/51x m (ft)	1fc/111x m (ft)	2fc/221x m (ft)	5fc/541x m (ft)
6 (20)	3.18	13 (44)	11 (36)	9 (30)	5 (16)
9 (30)	1.41	16 (53)	13 (42)	8 (27)	—
12 (40)	0.81	17 (56)	12 (40)	—	—

Mounting Height m (ft)	Side-to-Side Distance			
	0.5fc/51x m (ft)	1fc/111x m (ft)	2fc/221x m (ft)	5fc/541x m (ft)
6 (20)	26 (84)	20 (64)	13 (44)	5 (16)
9 (30)	27 (90)	20 (66)	11 (36)	—
12 (40)	29 (96)	17 (56)	—	—

NEMA 7x7, Frosted Glass
REPORT NUMBER: AMLGL8CF6BU
Luminaire Lumens 16,503

POLAR CANDELA DISTRIBUTION

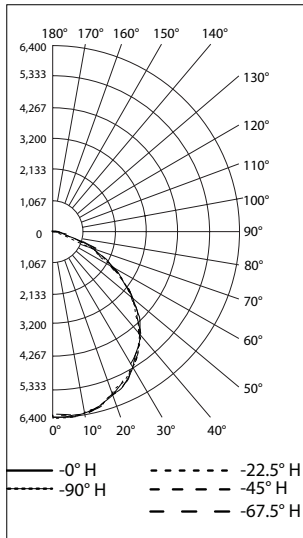

ISOFOOT CANDLE PLOT AT 45°

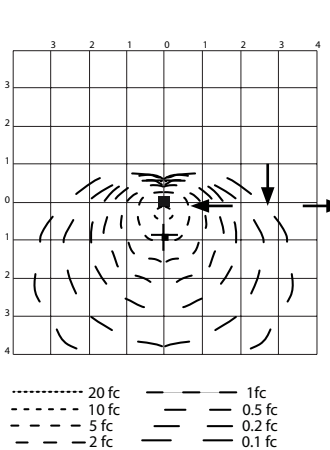

FLOOD SUMMARY

	Efficiency	Lumens	Horizontal Spread	Vertical Spread
Field (10%)	98.1%	16,189.8	155.3	150.7
Beam (50%)	71.3%	11,766.7	105.2	105.5
Total	100%	16,498.6		

Tilt Angle – 45 Degree LLF – 0.9

Mounting Height m (ft)	Maximum Point (fc)	Forward Throw Distance			
		0.5fc/51x m (ft)	1fc/111x m (ft)	2fc/221x m (ft)	5fc/541x m (ft)
6 (20)	5.76	17 (55)	11 (36)	10 (32)	6 (20)
9 (30)	2.56	16 (53)	9 (31)	9 (31)	—
12 (40)	1.43	17 (56)	19 (62)	9 (29)	—

Mounting Height m (ft)	Side-to-Side Distance			
	0.5fc/51x m (ft)	1fc/111x m (ft)	2fc/221x m (ft)	5fc/541x m (ft)
6 (20)	24 (78)	18 (60)	13 (44)	7 (22)
9 (30)	27 (88)	19 (62)	10 (34)	—
12 (40)	30 (98)	18 (58)	12 (38)	—

Areamaster™ Generation 2 LED Luminaire

Floodlight for Hazardous Locations

NEC/CEC:

Class I, Division 2, Groups A, B, C, D
 Class I, Zone 2 Group IIC
 Class II, Division 1 and 2, Groups E, F, G
 Class III
 Zone 20 and 21 Group IIIC

NEC/CEC:

Zone 22, Group IIIB
 Simultaneous Exposure
 Marine Outside Type (Salt Water) for USA ONLY
 Wet Locations
 Type 3R, 4, 4X, IP66/67

ATEX/IECEX:

Zone 2 and 22
 IP66
 II 3GD
 IK10
 Ex ec IIC T5

Photometric Data – DATA SHOWN IS ABSOLUTE

NEMA 7x6, Clear Glass

REPORT NUMBER: AMLGL6CG7BU

Luminaire Lumens 9,086

POLAR CANDELA DISTRIBUTION

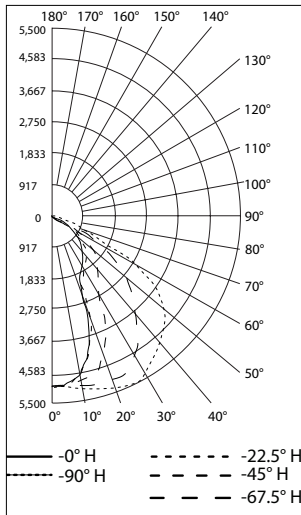

ISOFOOT CANDLE PLOT AT 45°

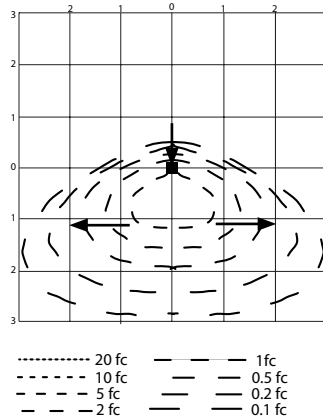

FLOOD SUMMARY

	Efficiency	Lumens	Horizontal Spread	Vertical Spread
Field (10%)	96.2%	8,738.1	134.9	112.1
Beam (50%)	62%	5,631.5	120.5	45.2
Total	100%	9,086.2		

Tilt Angle– 45 Degree LLF–0.9

Mounting Height m (ft)	Maximum Point (fc)	Forward Throw Distance			
		0.5fc/5lx m (ft)	1fc/11lx m (ft)	2fc/22lx m (ft)	5fc/54lx m (ft)
6 (20)	2.92	13 (42)	11 (36)	9 (28)	5 (15)
9 (30)	1.3	16 (53)	13 (42)	7 (24)	—
12 (40)	0.73	17 (56)	11 (36)	—	—

Mounting Height m (ft)	Side-to-Side Distance			
	0.5fc/5lx m (ft)	1fc/11lx m (ft)	2fc/22lx m (ft)	5fc/54lx m (ft)
6 (20)	24 (80)	20 (64)	13 (44)	5 (16)
9 (30)	26 (84)	18 (60)	11 (36)	—
12 (40)	27 (88)	15 (48)	—	—

NEMA 7x6, Clear Glass

REPORT NUMBER: AMLGL6WG7BU

Luminaire Lumens 8,111

POLAR CANDELA DISTRIBUTION

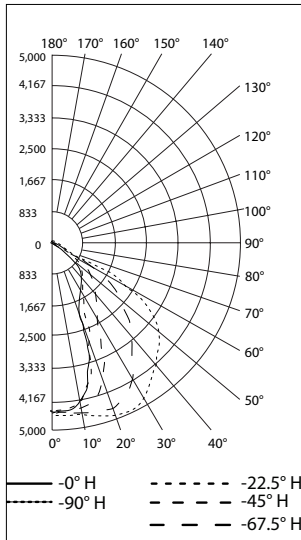

ISOFOOT CANDLE PLOT AT 45°

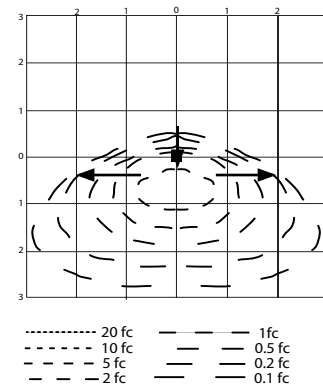

FLOOD SUMMARY

	Efficiency	Lumens	Horizontal Spread	Vertical Spread
Field (10%)	96.1%	7,798.3	135.3	112
Beam (50%)	61.5%	4,987.0	119.9	45
Total	100%	8,111.0		

Tilt Angle– 45 Degree LLF–0.9

Mounting Height m (ft)	Maximum Point (fc)	Forward Throw Distance			
		0.5fc/5lx m (ft)	1fc/11lx m (ft)	2fc/22lx m (ft)	5fc/54lx m (ft)
6 (20)	2.92	13 (42)	11 (36)	9 (28)	5 (15)
9 (30)	1.30	16 (53)	13 (42)	7 (24)	—
12 (40)	0.73	17 (56)	11 (36)	—	—

Mounting Height m (ft)	Side-to-Side Distance			
	0.5fc/5lx m (ft)	1fc/11lx m (ft)	2fc/22lx m (ft)	5fc/54lx m (ft)
6 (20)	24 (80)	20 (64)	13 (44)	5 (16)
9 (30)	26 (84)	18 (60)	11 (36)	—
12 (40)	27 (88)	15 (48)	—	—

Areamaster™ Generation 2 LED Luminaire Floodlight for Hazardous Locations

NEC/CEC:

Class I, Division 2, Groups A, B, C, D
Class I, Zone 2 Group IIC
Class II, Division 1 and 2, Groups E, F, G
Class III
Zone 20 and 21 Group IIIC

NEC/CEC:

Zone 22, Group IIIB
Simultaneous Exposure
Marine Outside Type (Salt Water) for USA ONLY
Wet Locations
Type 3R, 4, 4X, IP66/67

ATEX/IECEX:

Zone 2 and 22
IP66
II 3GD
IK10
Ex ec IIC T5

Photometric Data — DATA SHOWN IS ABSOLUTE

NEMA 7x6, Clear Glass

REPORT NUMBER: AMLGL7CG7BU

Luminaire Lumens 14,205

POLAR CANDELA DISTRIBUTION

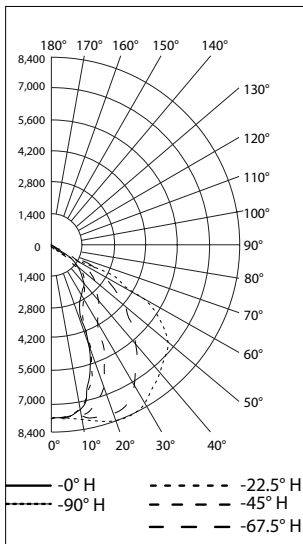

ISOFOOT CANDLE PLOT AT 45°

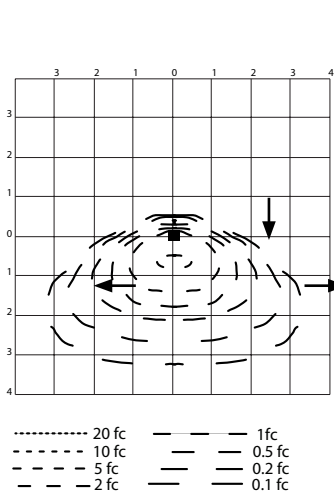

FLOOD SUMMARY

	Efficiency	Lumens	Horizontal Spread	Vertical Spread
Field (10%)	96.3%	13,678.5	135.3	112.5
Beam (50%)	62.6%	8,887.6	120.7	45.7
Total	100%	14,205.3		

Tilt Angle— 45 Degree LLF—0.9

Mounting Height m (ft)	Maximum Point (fc)	Forward Throw Distance			
		0.5fc/5lx m (ft)	1fc/11lx m (ft)	2fc/22lx m (ft)	5fc/54lx m (ft)
6 (20)	4.91	15 (48)	12 (40)	11 (35)	7 (25)
9 (30)	2.22	18 (60)	14 (45)	12 (38)	—
12 (40)	1.25	20 (64)	16 (52)	—	—

Side-to-Side Distance

Mounting Height m (ft)	0.5fc/5lx m (ft)	1fc/11lx m (ft)	2fc/22lx m (ft)	5fc/54lx m (ft)
6 (20)	29 (96)	24 (80)	18 (60)	11 (36)
9 (30)	33 (108)	27 (90)	16 (54)	—
12 (40)	37 (120)	24 (80)	—	—

NEMA 7x6, Clear Glass

REPORT NUMBER: AMLGL7WG7BU

Luminaire Lumens 11,971

POLAR CANDELA DISTRIBUTION

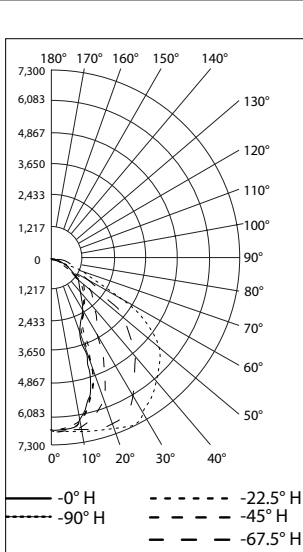

ISOFOOT CANDLE PLOT AT 45°

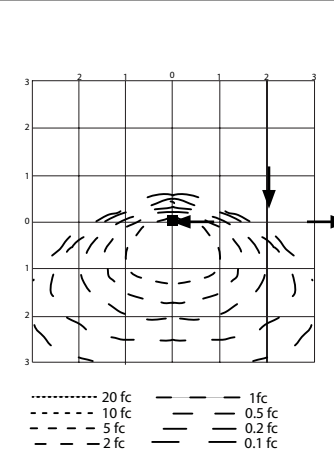

FLOOD SUMMARY

	Efficiency	Lumens	Horizontal Spread	Vertical Spread
Field (10%)	96.1%	11,503.9	135.2	112
Beam (50%)	62%	7,424.4	119.8	45.2
Total	100%	11,971.9		

Tilt Angle— 45 Degree LLF—0.9

Mounting Height m (ft)	Maximum Point (fc)	Forward Throw Distance			
		0.5fc/5lx m (ft)	1fc/11lx m (ft)	2fc/22lx m (ft)	5fc/54lx m (ft)
6 (20)	4.30	14 (46)	12 (40)	10 (32)	6 (20)
9 (30)	1.91	17 (54)	14 (45)	33 (10)	—
12 (40)	1.07	20 (64)	15 (50)	—	—

Side-to-Side Distance

Mounting Height m (ft)	0.5fc/5lx m (ft)	1fc/11lx m (ft)	2fc/22lx m (ft)	5fc/54lx m (ft)
6 (20)	27 (90)	22 (72)	16 (52)	9 (30)
9 (30)	33 (108)	24 (78)	15 (48)	—
12 (40)	34 (112)	22 (72)	—	—

Areamaster™ Generation 2 LED Luminaire

Floodlight for Hazardous Locations

NEC/CEC:

Class I, Division 2, Groups A, B, C, D
 Class I, Zone 2 Group IIC
 Class II, Division 1 and 2, Groups E, F, G
 Class III
 Zone 20 and 21 Group IIIC

NEC/CEC:

Zone 22, Group IIIB
 Simultaneous Exposure
 Marine Outside Type (Salt Water) for USA ONLY
 Wet Locations
 Type 3R, 4, 4X, IP66/67

ATEX/IECEX:

Zone 2 and 22
 IP66
 II 3GD
 IK10
 Ex ec IIC T5

Photometric Data – DATA SHOWN IS ABSOLUTE

NEMA 7x6, Clear Glass

REPORT NUMBER: **AMLGL8CG7BU**

Luminaire Lumens 18,467

POLAR CANDELA DISTRIBUTION

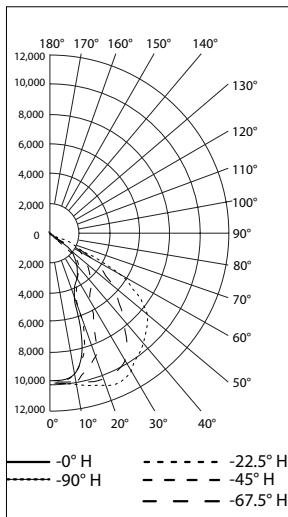

ISOFOOT CANDLE PLOT AT 45°

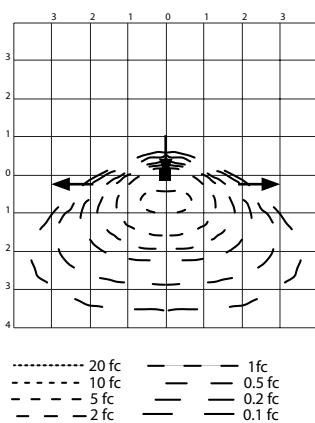

FLOOD SUMMARY

	Efficiency	Lumens	Horizontal Spread	Vertical Spread
Field (10%)	96.2%	17,761.1	135.1	112.2
Beam (50%)	62.5%	11,537.1	120.5	45.3
Total	100%	18,467.4		

Tilt Angle– 45 Degree LLF–0.9

Forward Throw Distance

Mounting Height m (ft)	Maximum Point (fc)	0.5fc/5lx m (ft)	1fc/11lx m (ft)	2fc/22lx m (ft)	5fc/54lx m (ft)
6 (20)	6.44	16 (52)	13 (44)	11 (36)	8 (26)
9 (30)	2.86	19 (63)	16 (54)	12 (39)	6 (21)
12 (40)	1.63	22 (72)	18 (60)	12 (40)	–

Side-to-Side Distance

Mounting Height m (ft)	0.5fc/5lx m (ft)	1fc/11lx m (ft)	2fc/22lx m (ft)	5fc/54lx m (ft)
6 (20)	32 (104)	26 (84)	21 (68)	12 (40)
9 (30)	37 (120)	31 (102)	20 (66)	4 (12)
12 (40)	39 (128)	29 (96)	15 (48)	–

NEMA 7x6, Clear Glass

REPORT NUMBER: **AMLGL8WG7BU**

Luminaire Lumens 15,556

POLAR CANDELA DISTRIBUTION

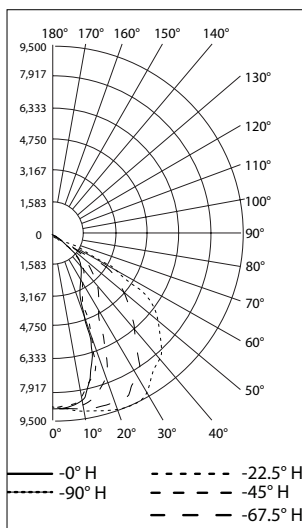

ISOFOOT CANDLE PLOT AT 45°

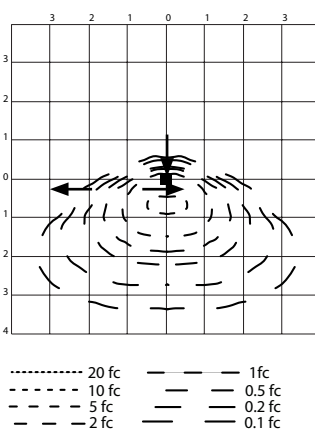

FLOOD SUMMARY

	Efficiency	Lumens	Horizontal Spread	Vertical Spread
Field (10%)	96.1%	14,945.7	135	111.8
Beam (50%)	62%	9,641.5	119.5	45
Total	100%	15,555.8		

Tilt Angle– 45 Degree LLF–0.9

Forward Throw Distance

Mounting Height m (ft)	Maximum Point (fc)	0.5fc/5lx m (ft)	1fc/11lx m (ft)	2fc/22lx m (ft)	5fc/54lx m (ft)
6 (20)	5.61	15 (50)	13 (42)	11 (36)	8 (26)
9 (30)	2.50	18 (60)	16 (53)	12 (38)	–
12 (40)	1.40	21 (70)	17 (56)	11 (36)	–

Side-to-Side Distance

Mounting Height m (ft)	0.5fc/5lx m (ft)	1fc/11lx m (ft)	2fc/22lx m (ft)	5fc/54lx m (ft)
6 (20)	30 (100)	24 (80)	20 (64)	11 (36)
9 (30)	36 (117)	27 (90)	18 (60)	–
12 (40)	37 (120)	24 (80)	12 (40)	–

Areamaster™ Generation 2 HL LED Luminaire

Floodlight for Hazardous Locations

NEC/CEC:

Class I, Division 2, Groups A, B, C, D
 Class I, Zone 2 Group IIC
 Class II, Division 1 and 2, Groups E, F, G
 Class III
 Zone 20 and 21 Group IIIC

NEC/CEC:

Zone 22, Group IIIB
 Simultaneous Exposure
 Marine Outside Type (Salt Water) for USA ONLY
 Wet Locations
 Type 3R, 4, 4X, IP66/67

ATEX/IECEX:

Zone 2, 22
 IP66
 II 3GD
 IK10
 Ex ec IIC T4

Applications

- Enclosed and gasketed fixtures suitable for use in:
 - A wide range of industrial, chemical processing and other areas where flammable gases and vapors are present, for example
 - Oil and Gas Refineries
 - Petrochemical Plants
 - Foundries
 - Drilling Rigs
 - Pulp and Paper Mills
 - Food and Beverage Processing Facilities
 - Loading Docks
 - Power Plants
 - Water and Wastewater Treatment Facilities
 - Other areas where corrosive, wet, dirty and tough environments are a problem
- IP66/IP67, Type 4X, marine and wet locations
- Locations requiring dependable, consistent lighting in extreme hot/cold temperature environments. -40°C to +65°C (-40°F to +149°F) ambient temperature range



Floodlight

Features

- Three lumen outputs provide up to 38,000 lumens.

Nominal Lumens ①	Wattage (W)	Efficacy (lpw)	HID Equivalent	Model Number
24,000	180	133	1000W	AMLHL1
30,000	225	133	1000-1500W	AMLHL2
38,000	310	123	1500W	AMLHL3

① Nominal lumen value for 5000K, detailed lumen information provided in tables.

- Choice of optics for optimal light distribution in a variety of applications.
- Separate field wiring compartment with screw terminal block for easy and secure connection (can accept UL/CSA 26-10AWG).
- Two 3/4" NPT entries provided.
- Yoke bracket is designed to accommodate traditional Areamaster brackets and slipfitters for easy retrofit.
- Choice of color temperature (CCT); 5000K cool white or 3000K warm white.
- Rugged and compact housing with superior thermal design translates to long luminaire life.
- Heavy duty, high temperature silicone rubber gaskets.
- Thermal shock and impact resistant clear or frosted glass lens.
- Standard 6KV surge protection.
- Captive fasteners secure one piece lens.
- Field replaceable LED driver and lens cover.

Options

- Improved safety cable design with multiple retention points, purchase separately
- Guard and visor available, purchase separately
- Slip-fitters and mounting brackets available for easy pole or wall mounting
- 10 KV Surge Protection
- Metric M20 thread adapter

Standard Materials

- Housing and lens door: copperfree (4/10 of 1% max.) aluminum
- Gaskets: silicone rubber
- Yoke: zinc plated HR steel
- Bolts: stainless steel
- Close up plugs: (1) aluminum provided
- Guard and safety cable: stainless steel
- Visor: Aluminum

Standard Finishes

- Housing, lens cover, visor and yoke mount: architectural bronze polyester

Related Products

- Round Tapered Steel Poles
- Hinged Steel Poled
- Square Tapered Steel Poles
- Square Steel Poles
- Floodlight Mounting Brackets

NEC/CEC Certifications and Compliances

- UL Standards:
 - UL844, Luminaires for Use in Hazardous Locations
 - UL1598, Luminaires
 - UL1598A, Luminaires for Installation on Marine Vessels
 - UL 8750, LED Equipment for Use in Lighting Products
- CSA Standards:
 - CSA C22.2 No. 250.0, Luminaires
 - CSA C22.2 No. 137, Luminaires for Use in Hazardous Locations
- cCSAus: 164460 Certificate Number: 70073613

Areamaster™ Generation 2 HL LED Luminaire

Floodlight for Hazardous Locations

NEC/CEC:

Class I, Division 2, Groups A, B, C, D
 Class I, Zone 2 Group IIC
 Class II, Division 1 and 2, Groups E, F, G
 Class III
 Zone 20 and 21 Group IIIC

NEC/CEC:

Zone 22, Group IIIB
 Simultaneous Exposure
 Marine Outside Type (Salt Water) for USA ONLY
 Wet Locations
 Type 3R, 4, 4X, IP66/67

ATEX/IECEX:

Zone 2, 22
 IP66
 II 3GD
 IK10
 Ex ec IIC T4

ATEX/IECEX Certifications and Compliances

- Certification Type: Areamaster High Lumen
 - Gas: Zone 2
 - Type of Protection: Ex ec IIC Gc
 - Temperature Class: T4 to T3
 - Dust: Zone 22
 - Type of Protection: Ex tc IIIC Dc
 - Surface Temperature: +85°C to +100°C (+185°F to +212°F)
- Ambient Temperature: -40°C up to +65°C (-40°F up to +268 °F)
- ATEX Certificate: SIRA 17ATEX3241
- IECEX Certificate: IECEX SIR 17.0079
- Index of Protection according EN/IEC 60529: IP66
- Impact Resistance (shock): IK10
- Photobiological Safety, IEC 62778 and IEC 62471: RG0

DesignLights™ Consortium (for the following models)

- All models pending.

Order using catalog numbering guides below or select catalog number from tables on following pages.

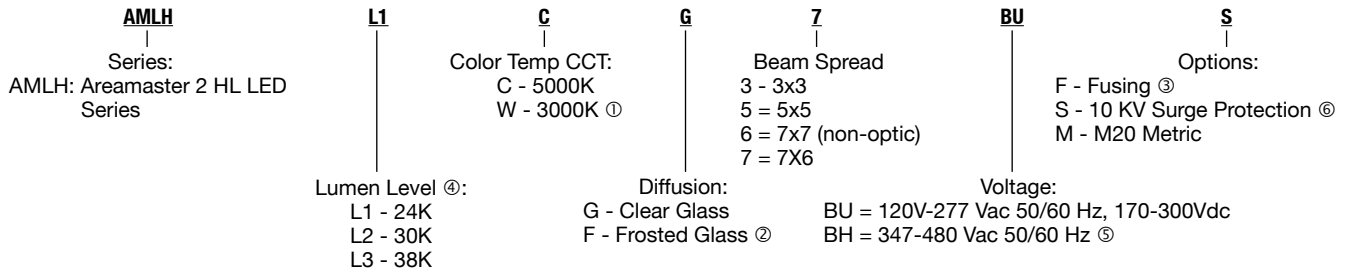

Lumen Output Tables ⑥:

Lumen Output for Clear Glass Lens			
	AMLHL1	AMLHL2	AMLHL3
NEMA 7x7 (Non Optic), 5000K CCT, CRI 70	23,500	30,100	37,000
NEMA 7x6, 3000K CCT, CRI 80	19,800	23,500	30,300
NEMA 7x6, 5000K CCT, CRI 70	22,700	28,100	35,400
NEMA 5x5, 3000K CCT, CRI 80	21,400	25,500	32,800
NEMA 5x5, 5000K CCT, CRI 70	24,100	30,000	38,300

Lumen Output for Frosted Glass Lens			
	AMLHL1	AMLHL2	AMLHL3
NEMA 7x7 (Non Optic), 5000K CCT	20,600	25,600	31,600

① 3000K CCT (warm) is not available with NEMA 7x7 light pattern.
 ② Frosted Glass is only available with NEMA 7x7 light pattern.
 ③ Use of fuse voids Marine rating. Fusing not available for NEC/CEC.
 ④ All lumen values are typical (tolerance +/-10%).
 ⑤ BH Voltage available for NEC/CEC only.
 ⑥ 10Kv Surge Protection available for NEC/CEC only.

Areamaster™ Generation 2 HL LED Luminaire

Floodlight for Hazardous Locations



NEC/CEC:
 Class I, Division 2, Groups A, B, C, D
 Class I, Zone 2 Group IIC
 Class II, Division 1 and 2, Groups E, F, G
 Class III
 Zone 20 and 21 Group IIIC

NEC/CEC:
 Zone 22, Group IIIB
 Simultaneous Exposure
 Marine Outside Type (Salt Water) for USA ONLY
 Wet Locations
 Type 3R, 4, 4X, IP66/67

ATEX/IECEX:
 Zone 2, 22
 IP66
 II 3GD
 IK10
 Ex ec IIC T4

Electrical Ratings ①

Voltage Suffix	Voltage (V)	Input Power (Watts)	Input Current (Amps)	Power Factor (PF)	Total Harmonic Distortion (THD)	Model Number
BU	120 Vac	180	1.52	>.9	<20%	AMLHL1
	277 Vac	176	0.67			
	170 Vdc	172	1.02	N/A	N/A	
	300 Vdc	170	0.57			
BH	347 Vac	179	0.52	>.9	<20%	
	480 Vac	179	0.39			
BU	120 Vac	231	1.94	>.9	<20%	AMLHL2
	277 Vac	231	0.88			
	170 Vdc	220	1.30	N/A	N/A	
	300 Vdc	217	0.72			
BH	347 Vac	219	0.64	>.9	<20%	
	480 Vac	219	0.47			
BU	120 Vac	317	2.67	>.9	<20%	AMLHL3
	277 Vac	303	1.15			
	170 Vdc	305	1.80	N/A	N/A	
	300 Vdc	298	0.99			
BH	347 Vac	299	0.87	>.9	<20%	
	480 Vac	298	0.63			

Luminaire Category	Image	Frontal Projected Area (FPA) ft ²	Drag Coefficient (DC)	Effective Projected Area (EPA) = FPA*DC ft ²
90° to Ground-Worst Case Mounting		2.04	1.20	2.45
45° to Ground-Standard Mounting		1.44	1.20	1.73

Surge Protection: Integral 6KV surge protection. Option for up to 10KV surge protection. (cCSAus only).
 ① All ratings are typical.

Areamaster™ Generation 2 HL LED Luminaire

Floodlight for Hazardous Locations

NEC/CEC:
 Class I, Division 2, Groups A, B, C, D
 Class I, Zone 2 Group IIC
 Class II, Division 1 and 2, Groups E, F, G
 Class III
 Zone 20 and 21 Group IIIC

NEC/CEC:
 Zone 22, Group IIIB
 Simultaneous Exposure
 Marine Outside Type (Salt Water) for USA ONLY
 Wet Locations
 Type 3R, 4, 4X, IP66/67

ATEX/IECEX:
 Zone 2, 22
 IP66
 II 3GD
 IK10
 Ex ec IIC T4

NEC/CEC Temperature Codes

Lamp Line Voltage	Ambient Temperature		Gas		Dust		Model Number	
	°C (°F)	°C (°F)	Class I, Division 2 ① Groups A, B, C, D	Class I, Zone 2 Group IIC	Class II, Division 1 Groups E,F,G	Zone 20, Group IIIC		Class I Division 2 and Class 2 Division I
120-277 Vac/ 170-300 Vdc; 347-480 Vac	40 (104)	90 (194)	T4A	T4	T6	T6	T4A	AMLHL1
	55 (131)	90 (194)	T4A	T4	T6	T6	T4A	
	65 (149)	90 (194)	T4	T4	T5	T5	T4	
120-277 Vac/ 170-300 Vdc; 347-480 Vac	40 (104)	90 (194)	T4	T4	T6	T6	T4	AMLHL2
	55 (131)	90 (194)	T4	T4	T5	T5	T4	
	65 (149)	90 (194)	T3C	T3	T5	T5	T3C	
120-277 Vac/ 170-300 Vdc; 347-480 Vac	40 (104)	90 (194)	T3C	T3	T6	T6	T3C	AMLHL3
	55 (131)	90 (194)	T3C	T3	T5	T5	T3C	

Ambient Temperature Range: -40 °C to +65 °C (-40 °F to +149 °F)

ATEX/IECEX Temperature Codes

Ta= +40 °C (+104 °F)	Gas T Rating			Dust Surface Temperature			Model Number
	Ta= +55 °C (+131 °F)	Ta= +65 °C (+149 °F)	Ta= +40 °C (+104 °F)	Ta= +55 °C (+131 °F)	Ta= +65 °C (+149 °F)		
T4	T4	T4	T85°C	T85°C	T100°C	AMLGL6	
T4	T4	T3	T85°C	T100°C	T100°C	AMLGL7	
T3	T3	—	T85°C	T100°C	—	AMLGL8	

“T” Numbers Represent the Maximum Internal Temperature ① or Maximum Surface Temperature ②

“T” #	NEC/CEC															
	T1	350	325	T2	T2A	T2B	T2C	T2D	T3	T3A	T3B	T3C	T4	T4A	T5	T6
Temp. Range °C (°F)	351-450 (664-842)	326-350 (619-662)	301-325 (574-617)	281-300 (538-572)	261-280 (502-536)	231-260 (448-500)	216-230 (421-446)	201-215 (394-419)	181-200 (358-392)	166-180 (331-356)	161-165 (322-329)	136-160 (277-320)	121-135 (250-275)	101-120 (214-248)	86-100 (187-212)	85 (185)

“T” #	ATEX/IECEX					
	T1	T2	T3	T4	T5	T6
Temp. Range °C (°F)	301-450 (547-842)	201-300 (394-572)	136-200 (277-392)	101-135 (214-275)	86-100 (187-212)	85 (185)

① T numbers represent the maximum internal temperature for Class I, Division 2 and Class I, Zone 2 locations designated by the NEC.
 ② T numbers represent the maximum surface temperature under a dust blanket for Class II, Division 1 and 2 as designated by the NEC.

Areamaster™ Generation 2 HL LED Luminaire

Floodlight for Hazardous Locations

NEC/CEC:

Class I, Division 2, Groups A, B, C, D
 Class I, Zone 2 Group IIC
 Class II, Division 1 and 2, Groups E, F, G
 Class III
 Zone 20 and 21 Group IIIC

NEC/CEC:

Zone 22, Group IIIB
 Simultaneous Exposure
 Marine Outside Type (Salt Water) for USA ONLY
 Wet Locations
 Type 3R, 4, 4X, IP66/67

ATEX/IECEX:

Zone 2, 22
 IP66
 II 3GD
 IK10
 Ex ec IIC T4

CCT	Lumen Output	Wattage	Efficacy (lm/W)	Optical Pattern	Catalog Number ①
Clear Glass					
120-277 Vac/170-300 Vdc					
5000K (cool white)	23500	174	135	NEMA 7x7 (150°x150°)	AMLHL1CG6BU
5000K (cool white)	24100	177	136	NEMA 5x5 (75°x75°)	AMLHL1CG5BU
5000K (cool white)	22700	177	128	NEMA 7x6 (136°x113°)	AMLHL1CG7BU
3000K (warm white)	21400	176	122	NEMA 5x5 (75°x75°)	AMLHL1WG5BU
3000K (warm white)	19800	177	112	NEMA 7x6 (136°x113°)	AMLHL1WG7BU
5000K (cool white)	30100	226	133	NEMA 7x7 (150°x150°)	AMLHL2CG6BU
5000K (cool white)	30000	228	132	NEMA 5x5 (75°x75°)	AMLHL2CG5BU
5000K (cool white)	28100	226	124	NEMA 7x6 (136°x113°)	AMLHL2CG7BU
3000K (warm white)	25500	215	119	NEMA 5x5 (75°x75°)	AMLHL2WG5BU
3000K (warm white)	23500	214	110	NEMA 7x6 (136°x113°)	AMLHL2WG7BU
5000K (cool white)	37000	303	122	NEMA 7x7 (150°x150°)	AMLHL3CG6BU
5000K (cool white)	38300	313	122	NEMA 5x5 (75°x75°)	AMLHL3CG5BU
5000K (cool white)	35400	306	116	NEMA 7x6 (136°x113°)	AMLHL3CG7BU
3000K (warm white)	32800	295	111	NEMA 5x5 (75°x75°)	AMLHL3WG5BU
3000K (warm white)	30300	295	103	NEMA 7x6 (136°x113°)	AMLHL3WG7BU
347-480 Vac					
5000K (cool white)	23500	174	135	NEMA 7x7 (150°x150°)	AMLHL1CG6BH
5000K (cool white)	24100	177	136	NEMA 5x5 (75°x75°)	AMLHL1CG5BH
5000K (cool white)	22700	177	128	NEMA 7x6 (136°x113°)	AMLHL1CG7BH
3000K (warm white)	21400	176	122	NEMA 5x5 (75°x75°)	AMLHL1WG5BH
3000K (warm white)	19800	177	112	NEMA 7x6 (136°x113°)	AMLHL1WG7BH
5000K (cool white)	30100	226	133	NEMA 7x7 (150°x150°)	AMLHL2CG6BH
5000K (cool white)	30000	228	132	NEMA 5x5 (75°x75°)	AMLHL2CG5BH
5000K (cool white)	28100	226	124	NEMA 7x6 (136°x113°)	AMLHL2CG7BH
3000K (warm white)	25500	215	119	NEMA 5x5 (75°x75°)	AMLHL2WG5BH
3000K (warm white)	23500	214	110	NEMA 7x6 (136°x113°)	AMLHL2WG7BH
5000K (cool white)	37000	303	122	NEMA 7x7 (150°x150°)	AMLHL3CG6BH
5000K (cool white)	38300	313	122	NEMA 5x5 (75°x75°)	AMLHL3CG5BH
5000K (cool white)	35400	306	116	NEMA 7x6 (136°x113°)	AMLHL3CG7BH
3000K (warm white)	32800	295	111	NEMA 5x5 (75°x75°)	AMLHL3WG5BH
3000K (warm white)	30300	295	103	NEMA 7x6 (136°x113°)	AMLHL3WG7BH
Frosted Glass					
120-277 Vac/170-300 Vdc					
5000K (cool white)	20600	176	116	NEMA 7x7 (150x150)	AMLHL1CF6BU
5000K (cool white)	25600	226	113	NEMA 7x7 (150x150)	AMLHL2CF6BU
5000K (cool white)	31600	303	104	NEMA 7x7 (150x150)	AMLHL3CF6BU
347-480 Vac					
5000K (cool white)	20600	176	116	NEMA 7x7 (150x150)	AMLHL1CF6BH
5000K (cool white)	25600	226	113	NEMA 7x7 (150x150)	AMLHL2CF6BH
5000K (cool white)	31600	303	104	NEMA 7x7 (150x150)	AMLHL3CF6BH

APPLETON™

LED/FLOODLIGHTS: NEC/CEC, ATEX/IECEX ENCLOSED AND GASKETED



① For Fusing option, add suffix **F** to end of part number, example AMLHL1CG6BUF.
 For 10KV surge protection, add suffix **S** to end of part number, example AMLHL1CG7BUS.
 For both Fusing and 10KV surge, add suffix **FS** to end of part number, example AMLHL1CG7BUFS.

Areamaster™ Generation 2 HL LED Luminaire Floodlight for Hazardous Locations

NEC/CEC:

Class I, Division 2, Groups A, B, C, D
Class I, Zone 2 Group IIC
Class II, Division 1 and 2, Groups E, F, G
Class III
Zone 20 and 21 Group IIIC

NEC/CEC:

Zone 22, Group IIIB
Simultaneous Exposure
Marine Outside Type (Salt Water) for USA ONLY
Wet Locations
Type 3R, 4, 4X, IP66/67

ATEX/IECEX:

Zone 2, 22
IP66
II 3GD
IK10
Ex ec IIC T4

Accessories and Replacement Parts

	Description	Catalog Number
Crossarm Mounting Bracket		
	Has 180° horizontal adjustment — degree marked. Facilitates mounting floodlight to crossarm or other flat surface, or to G-AM-8-WB. Includes floodlight yoke bolts. Malleable iron, zinc plated, chromate sealed, architectural bronze polyester finish.	G-AM-8-CA
Pipe or Wall Mount Bracket		
	Used with G-AM-8-CA. Clamps to 1" to 2-1/2" pipe, vertical or horizontal, or mounts on flat surfaces. Includes U-bolt and crossarm bracket bolts. Malleable iron, zinc plated, chromate sealed, with architectural bronze polyester finish.	G-AM-8-WB
		
Crossarm Mounting Bracket (G-AM-8-CA) used with Pipe or Wall Mount Bracket (G-AM-8-WB).		
Poletop Slip-Fitter		
	Slip-fits 1-1/2" or 2" pipe size poletop tenons. Includes floodlight yoke bolts, 3 locking bolts, and cord grip. Body is malleable iron-zinc plated, chromate sealed, with cast aluminum cap. Assembly has architectural bronze polyester finish.	G-SF20
	Slip-fits 1" or 1-1/2" pipe size poletop tenons. Includes floodlight yoke bolts, 3 locking bolts, and cord grip. Body is malleable iron-zinc plated, chromate sealed, with cast aluminum cap. Assembly has architectural bronze polyester finish.	AMLEDSF1
Poletop Slip-Fitter		
	Slip-fits 2" or 2-1/2" poletop tenons. Includes floodlight yoke bolts, 3 locking bolts, and cord grip. Malleable iron, zinc plated, chromate sealed, with architectural bronze polyester finish.	G-AM-8-SF

Areamaster™ Generation 2 HL LED Luminaire

Floodlight for Hazardous Locations

NEC/CEC:

Class I, Division 2, Groups A, B, C, D
 Class I, Zone 2 Group IIC
 Class II, Division 1 and 2, Groups E, F, G
 Class III
 Zone 20 and 21 Group IIIC





NEC/CEC:

Zone 22, Group IIIB
 Simultaneous Exposure
 Marine Outside Type (Salt Water) for USA ONLY
 Wet Locations
 Type 3R, 4, 4X, IP66/67

ATEX/IECEX:

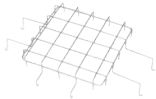
Zone 2, 22
 IP66
 II 3GD
 IK10
 Ex ec IIC T4

Accessories and Replacement Parts

	Description	Catalog Number
Wall Mount Bracket		
	Used with G-AM-8-SF and GSF-20 to provide a wall mounting option. Galvanized Steel.	GPSWB6
Wire Guard		
	Stainless steel.	LHGUARD
Safety Cable		
	Stainless steel.	LEDSC
Visor		
	Steel with architectural bronze polyester finish. For Dark Sky Friendly design.	AMLHV
Portable Floodlight Base		
	Portable floodlight base for temporary lighting applications. To be used with wire guard. Malleable iron with architectural bronze polyester finish.	G-AM-PFB

Areamaster™ Generation 2 HL LED Luminaire

Floodlight for Hazardous Locations

NEC/CEC:

Class I, Division 2, Groups A, B, C, D
 Class I, Zone 2 Group IIC
 Class II, Division 1 and 2, Groups E, F, G
 Class III
 Zone 20 and 21 Group IIIC

NEC/CEC:

Zone 22, Group IIIB
 Simultaneous Exposure
 Marine Outside Type (Salt Water) for USA ONLY
 Wet Locations
 Type 3R, 4, 4X, IP66/67

ATEX/IECEX:

Zone 2, 22
 IP66
 II 3GD
 IK10
 Ex ec IIC T4

Accessories and Replacement Parts



Replacement Covers



AMLHCLEAR

AMLHFROST

Replacement Drivers

	Voltage	Driver Wattage	Constant Current Setting	Luminaire Model	CCT	Catalog Number
	BU	150 watt	915mA	AMLHL3C	5K	APMS150C105UD91
	BH					APMS150C105HD91
	BU	150 watt	680mA	AMLHL2C	5k	APMS150C105U68
	BH					APMS150C105HD68
	BU	150 watt	890mA	AMLHL3W	3K	APMS150C105UD89
	BH					APMS150C105HD89
	BU	150 watt	650mA	AMLHL2C	3K	APMS150C105UD65
	BH					APMS150C105HD65
	BU	100 watt	530mA	AMLHL1C, AMLHL1W	5K and 3K	APMS100C105UD53
	BH					APMS100C105HD53

Areamaster Generation 2 Accessory Weights

Description	Weight in kg (lbs)
AMLHL1, AMLHL2, AMLHL3 Luminaires	16.1 (35.4)
Yoke Bracket	1.4 (3.1)
Visor	0.3 (0.6)
Guard	0.2 (0.4)
Safety Cable	0.2 (0.4)
Crossarm Mounting Bracket G-AM-8-CA	1.4 (3.1)
Pipe or Wall Mount Bracket G-AM-8-WB	2.9 (6.4)
Poletop Slip-Fitter GSF20	1.4 (3.1)
Poletop Slip-Fitter AMLEDSF1	2.4 (5.3)
Poletop Slip-Fitter GAM8SF	—
—	—

Areamaster™ Generation 2 HL LED Luminaire

Floodlight for Hazardous Locations

NEC/CEC:

Class I, Division 2, Groups A, B, C, D
 Class I, Zone 2 Group IIC
 Class II, Division 1 and 2, Groups E, F, G
 Class III
 Zone 20 and 21 Group IIIC

NEC/CEC:

Zone 22, Group IIIB
 Simultaneous Exposure
 Marine Outside Type (Salt Water) for USA ONLY
 Wet Locations
 Type 3R, 4, 4X, IP66/67

ATEX/IECEX:

Zone 2, 22
 IP66
 II 3GD
 IK10
 Ex ec IIC T4

Dimensions in Millimeters (Inches)

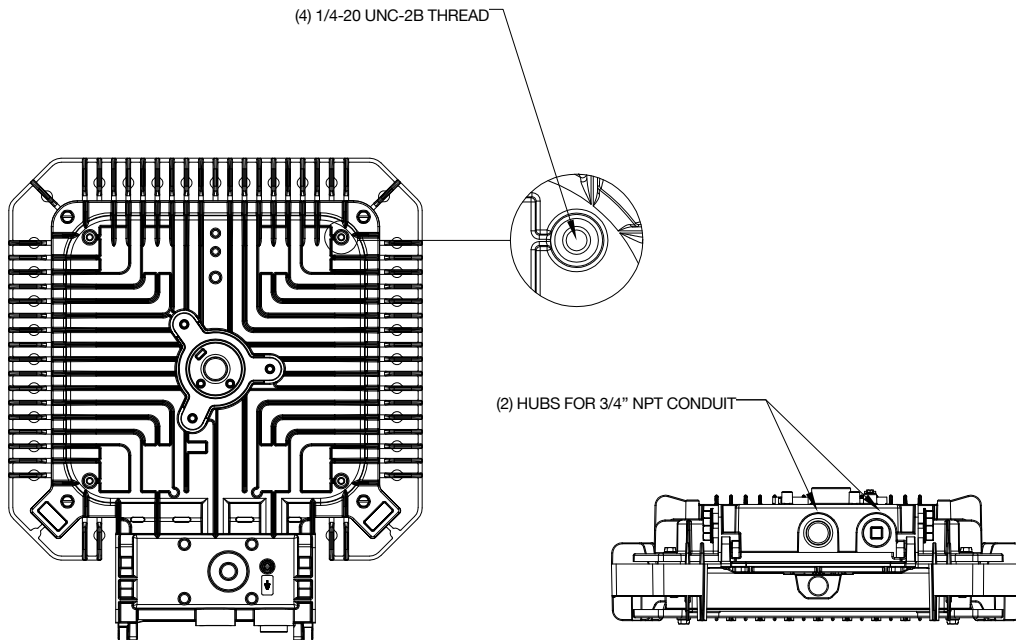
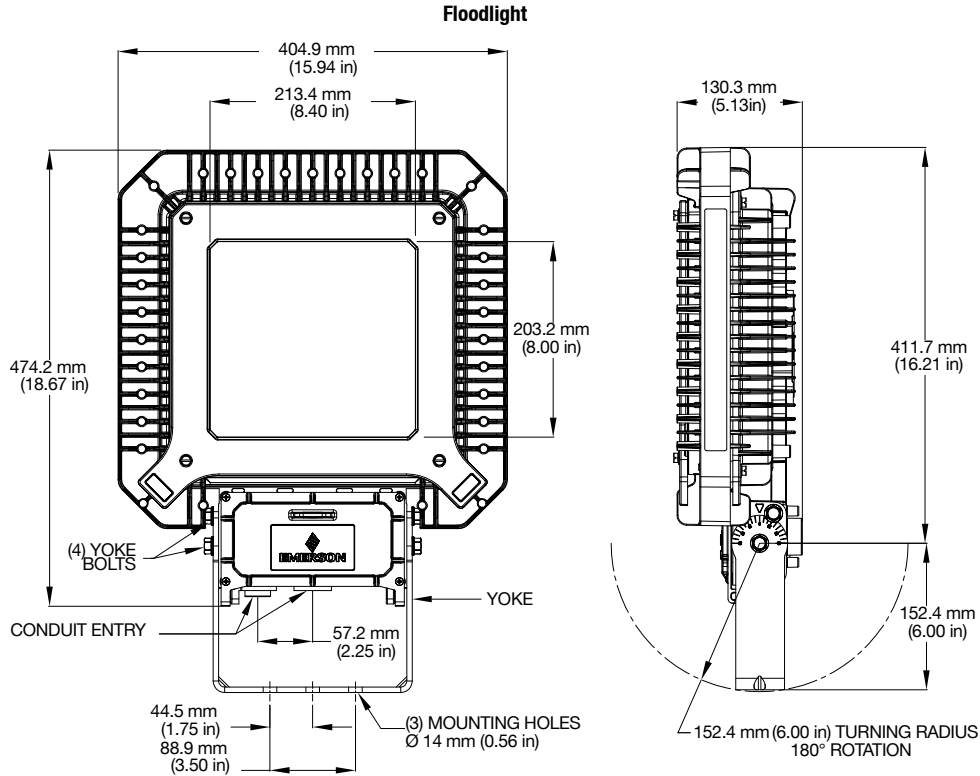

APPLETON™

LED/FLOODLIGHTS: NEC/CEC, ATEX/IECEX ENCLOSED AND GASKETED

Areamaster™ Generation 2 HL LED Luminaire

Floodlight for Hazardous Locations

NEC/CEC:
 Class I, Division 2, Groups A, B, C, D
 Class I, Zone 2 Group IIC
 Class II, Division 1 and 2, Groups E, F, G
 Class III
 Zone 20 and 21 Group IIIC

NEC/CEC:
 Zone 22, Group IIIB
 Simultaneous Exposure
 Marine Outside Type (Salt Water) for USA ONLY
 Wet Locations
 Type 3R, 4, 4X, IP66/67

ATEX/IECEX:
 Zone 2, 22
 IP66
 II 3GD
 IK10
 Ex ec IIC T4

Photometric Data — DATA SHOWN IS ABSOLUTE

NEMA 5x5, Clear Glass

REPORT NUMBER: AMLHL1CG5BU

Luminaire Lumens 24,140

POLAR CANDELA DISTRIBUTION

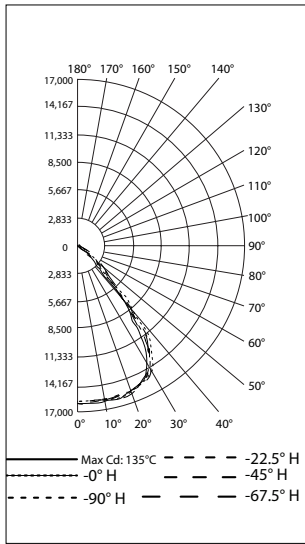

ISOFOOT CANDLE PLOT AT 45°

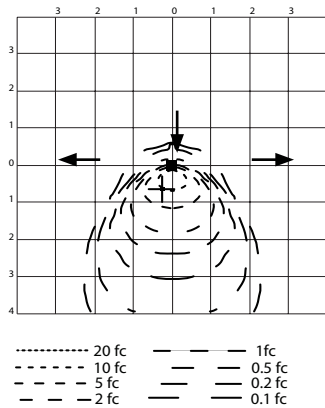

FLOOD SUMMARY

	Efficiency	Lumens	Horizontal Spread	Vertical Spread
Field (10%)	94.8%	22,874.5	91.7	91.3
Beam (50%)	84%	20,284.1	75.4	75.9
Total	100%	24,137.4		

Tilt Angle— 45 Degree LLF—0.9

Mounting Height m (ft)	Maximum Point (fc)	Forward Throw Distance			
		0.5fc/5lx m (ft)	1fc/11lx m (ft)	2fc/22lx m (ft)	5fc/54lx m (ft)
9 (30)	8.96	27 (90)	21 (68)	16 (54)	10 (33)
12 (40)	5.04	29 (96)	22 (72)	16 (52)	9 (28)
15 (50)	3.19	30 (100)	23 (75)	15 (50)	—
18 (60)	2.22	32 (105)	24 (78)	14 (45)	—

Mounting Height m (ft)	Side-to-Side Distance			
	0.5fc/5lx m (ft)	1fc/11lx m (ft)	2fc/22lx m (ft)	5fc/54lx m (ft)
9 (30)	29 (96)	24 (78)	19 (63)	14 (45)
12 (40)	32 (104)	27 (88)	20 (64)	10 (32)
15 (50)	37 (120)	29 (95)	18 (60)	—
18 (60)	40 (132)	29 (96)	15 (48)	—

NEMA 5x5, Clear Glass

REPORT NUMBER: AMLHL1WG5BU

Luminaire Lumens 21,416

POLAR CANDELA DISTRIBUTION

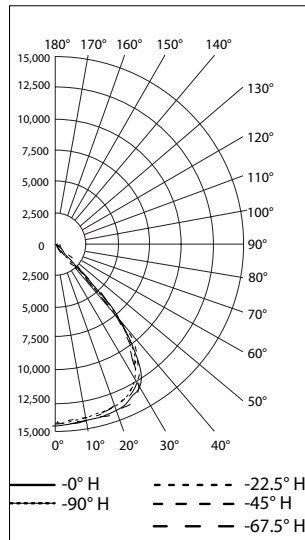

ISOFOOT CANDLE PLOT AT 45°

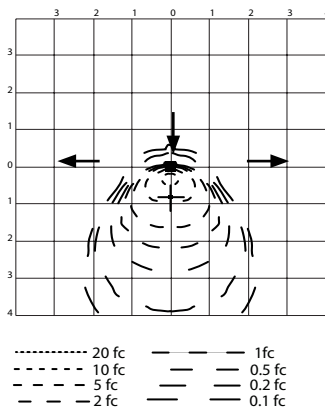

FLOOD SUMMARY

	Efficiency	Lumens	Horizontal Spread	Vertical Spread
Field (10%)	95%	20,343.5	95.6	94.3
Beam (50%)	84%	17,982.6	79.7	80.3
Total	100%	21,416.2		

Tilt Angle— 45 Degree LLF—0.9

Mounting Height m (ft)	Maximum Point (fc)	Forward Throw Distance			
		0.5fc/5lx m (ft)	1fc/11lx m (ft)	2fc/22lx m (ft)	5fc/54lx m (ft)
9 (30)	8.96	29 (96)	23 (75)	17 (57)	36 (11)
12 (40)	5.04	32 (104)	24 (80)	18 (60)	10 (32)
15 (50)	3.19	34 (110)	26 (85)	18 (60)	8 (25)
18 (60)	2.22	36 (117)	27 (90)	16 (54)	—

Mounting Height m (ft)	Side-to-Side Distance			
	0.5fc/5lx m (ft)	1fc/11lx m (ft)	2fc/22lx m (ft)	5fc/54lx m (ft)
9 (30)	27 (90)	22 (72)	18 (60)	13 (42)
12 (40)	30 (100)	24 (80)	20 (64)	7 (24)
15 (50)	37 (120)	27 (90)	18 (60)	—
18 (60)	37 (120)	27 (90)	15 (48)	—

Areamaster™ Generation 2 HL LED Luminaire

Floodlight for Hazardous Locations

NEC/CEC:
 Class I, Division 2, Groups A, B, C, D
 Class I, Zone 2 Group IIC
 Class II, Division 1 and 2, Groups E, F, G
 Class III
 Zone 20 and 21 Group IIIC

NEC/CEC:
 Zone 22, Group IIIB
 Simultaneous Exposure
 Marine Outside Type (Salt Water) for USA ONLY
 Wet Locations
 Type 3R, 4, 4X, IP66/67

ATEX/IECEX:
 Zone 2, 22
 IP66
 II 3GD
 IK10
 Ex ec IIC T4

Photometric Data – DATA SHOWN IS ABSOLUTE

NEMA 5x5, Clear Glass

REPORT NUMBER: AMLHL2CG5BU

Luminaire Lumens 30,068

POLAR CANDELA DISTRIBUTION

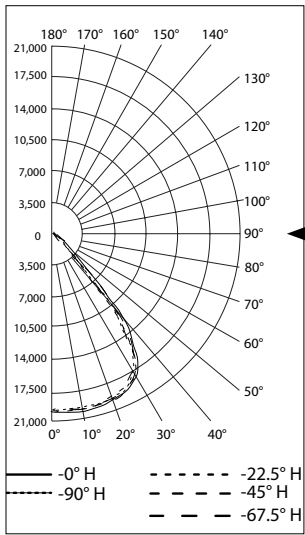

ISOFOOT CANDLE PLOT AT 45°

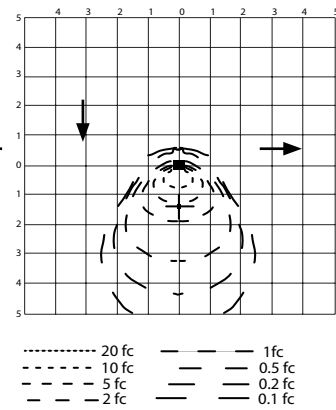

FLOOD SUMMARY

	Efficiency	Lumens	Horizontal Spread	Vertical Spread
Field (10%)	94.6%	28,436.7	95.8	93.5
Beam (50%)	83.6%	25,124.4	78.8	79.8
Total	100%	30,069.5		

Tilt Angle– 45 Degree LLF–0.9

Mounting Height m (ft)	Maximum Point (fc)	Forward Throw Distance			
		0.5fc/5lx m (ft)	1fc/11lx m (ft)	2fc/22lx m (ft)	5fc/54lx m (ft)
9 (30)	3.84	29 (96)	23 (75)	17 (57)	36 (11)
12 (40)	2.15	32 (104)	24 (80)	18 (60)	10 (32)
15 (50)	1.38	34 (110)	26 (85)	18 (60)	8 (25)
18 (60)	0.97	36 (117)	27 (90)	16 (54)	–

Side-to-Side Distance

Mounting Height m (ft)	0.5fc/5lx m (ft)	1fc/11lx m (ft)	2fc/22lx m (ft)	5fc/54lx m (ft)
9 (30)	31 (102)	26 (84)	19 (61)	15 (48)
12 (40)	34 (112)	29 (96)	22 (72)	12 (40)
15 (50)	40 (130)	30 (100)	24 (80)	9 (30)
18 (60)	44 (144)	33 (108)	22 (72)	–

NEMA 5x5, Clear Glass

REPORT NUMBER: AMLHL2WG5BU

Luminaire Lumens 25.490

POLAR CANDELA DISTRIBUTION

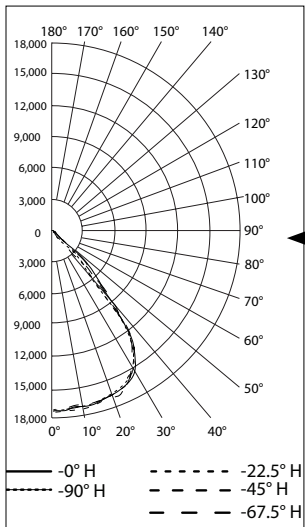

ISOFOOT CANDLE PLOT AT 45°

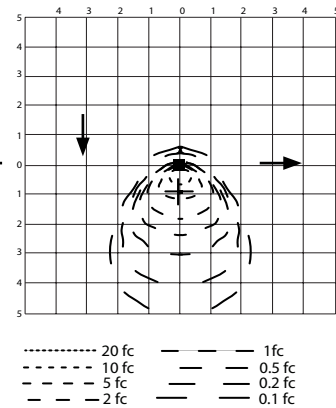

FLOOD SUMMARY

	Efficiency	Lumens	Horizontal Spread	Vertical Spread
Field (10%)	94.9%	24,197.1	95.5	93.5
Beam (50%)	84.5%	21,539.9	80	79.7
Total	100%	25,489.8		

Tilt Angle– 45 Degree LLF–0.9

Mounting Height m (ft)	Maximum Point (fc)	Forward Throw Distance m (ft)			
		0.5fc/5lx m (ft)	1fc/11lx m (ft)	2fc/22lx m (ft)	5fc/54lx m (ft)
9 (30)	6.94	28 (93)	21 (69)	16 (54)	10 (33)
12 (40)	3.85	30 (100)	23 (76)	17 (56)	9 (28)
15 (50)	2.46	31 (103)	23 (75)	15 (50)	–
18 (60)	1.71	33 (108)	24 (78)	15 (48)	–

Side-to-Side Distance

Mounting Height m (ft)	0.5fc/5lx m (ft)	1fc/11lx m (ft)	2fc/22lx m (ft)	5fc/54lx m (ft)
9 (30)	27 (90)	22 (72)	18 (60)	13 (42)
12 (40)	30 (100)	24 (80)	20 (64)	7 (24)
15 (50)	37 (120)	27 (90)	18 (60)	–
18 (60)	37 (120)	27 (90)	15 (48)	–

Areamaster™ Generation 2 HL LED Luminaire

Floodlight for Hazardous Locations

NEC/CEC:
 Class I, Division 2, Groups A, B, C, D
 Class I, Zone 2 Group IIC
 Class II, Division 1 and 2, Groups E, F, G
 Class III
 Zone 20 and 21 Group IIIC

NEC/CEC:
 Zone 22, Group IIIB
 Simultaneous Exposure
 Marine Outside Type (Salt Water) for USA ONLY
 Wet Locations
 Type 3R, 4, 4X, IP66/67

ATEX/IECEX:
 Zone 2, 22
 IP66
 II 3GD
 IK10
 Ex ec IIC T4

Photometric Data – DATA SHOWN IS ABSOLUTE

NEMA 5x5, Clear Glass
 REPORT NUMBER: **AMLHL3CG5BU**

Luminaire Lumens 38,350

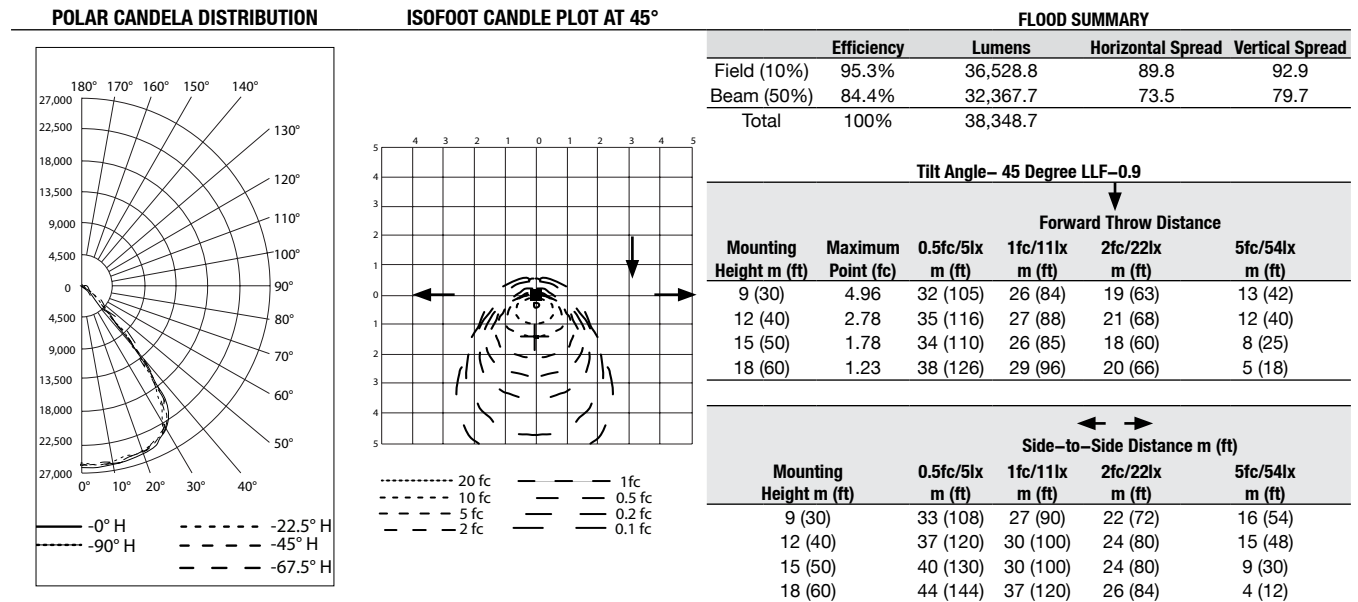

NEMA 5x5, Clear Glass
 REPORT NUMBER: **AMLHL3WG5BU**

Luminaire Lumens 32,835

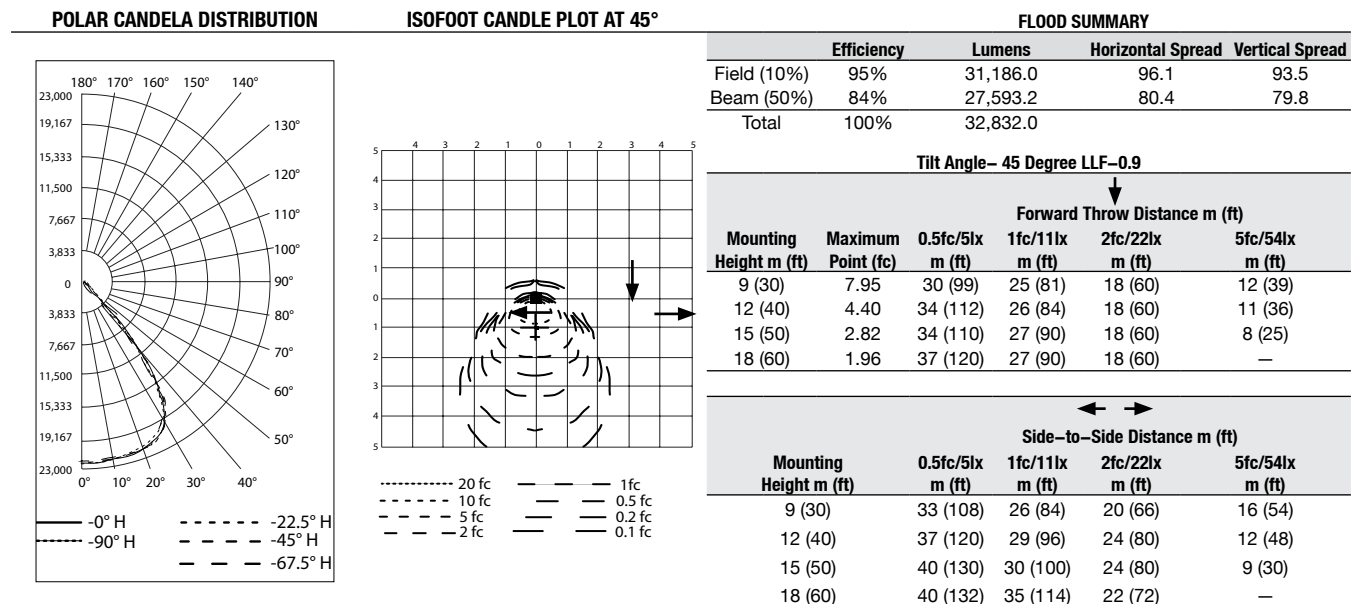

APPLETON™
 LED/FLOODLIGHTS: NEC/CEC, ATEX/IECEX ENCLOSED AND GASKETED

Areamaster™ Generation 2 HL LED Luminaire

Floodlight for Hazardous Locations

NEC/CEC:
 Class I, Division 2, Groups A, B, C, D
 Class I, Zone 2 Group IIC
 Class II, Division 1 and 2, Groups E, F, G
 Class III
 Zone 20 and 21 Group IIIC

NEC/CEC:
 Zone 22, Group IIIB
 Simultaneous Exposure
 Marine Outside Type (Salt Water) for USA ONLY
 Wet Locations
 Type 3R, 4, 4X, IP66/67

ATEX/IECEX:
 Zone 2, 22
 IP66
 II 3GD
 IK10
 Ex ec IIC T4

Photometric Data – DATA SHOWN IS ABSOLUTE

NEMA 7x6 Clear Glass

REPORT NUMBER: AMLHL1CG7BU

Luminaire Lumens 22,661

POLAR CANDELA DISTRIBUTION

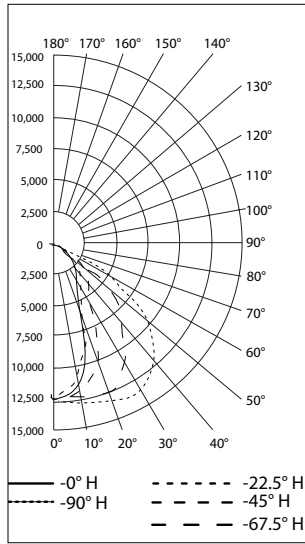

ISOFOOT CANDLE PLOT AT 45°

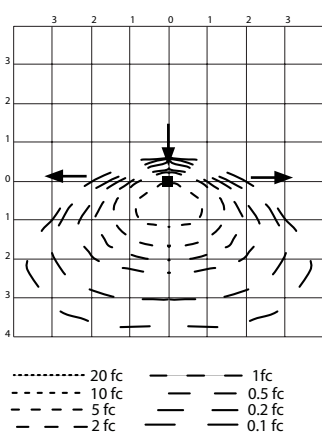

FLOOD SUMMARY

	Efficiency	Lumens	Horizontal Spread	Vertical Spread
Field (10%)	95.8%	21,708.2	134.1	111.1
Beam (50%)	61.4%	13,911.6	118.5	44.9
Total	100%	22,657.0		

Tilt Angle– 45 Degree LLF–0.9

Mounting Height m (ft)	Maximum Point (fc)	Forward Throw Distance m (ft)			
		0.5fc/5lx m (ft)	1fc/11lx m (ft)	2fc/22lx m (ft)	5fc/54lx m (ft)
9 (30)	3.64	19 (63)	17 (57)	14 (54)	9 (29)
12 (40)	2.08	23 (76)	20 (64)	15 (48)	—
15 (50)	1.33	26 (85)	20 (65)	12 (40)	—
18 (60)	0.93	27 (90)	20 (66)	—	—

Side-to-Side Distance

Mounting Height m (ft)	0.5fc/5lx m (ft)	1fc/11lx m (ft)	2fc/22lx m (ft)	5fc/54lx m (ft)
9 (30)	38 (126)	33 (108)	23 (75)	13 (42)
12 (40)	44 (144)	32 (104)	22 (72)	—
15 (50)	46 (150)	30 (100)	15 (50)	—
18 (60)	46 (150)	29 (96)	—	—

NEMA 7x6 Clear Glass

REPORT NUMBER: AMLHL1WG7BU

Luminaire Lumens 19,753

POLAR CANDELA DISTRIBUTION

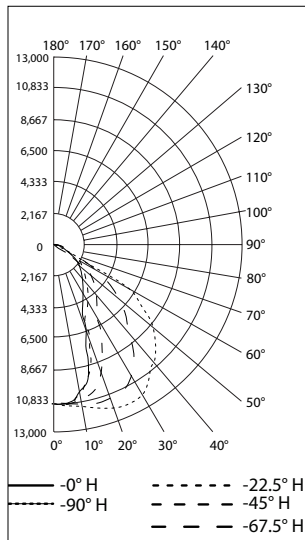

ISOFOOT CANDLE PLOT AT 45°

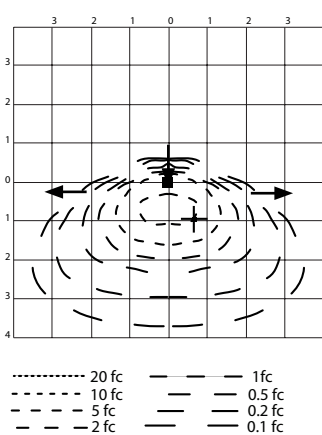

FLOOD SUMMARY

	Efficiency	Lumens	Horizontal Spread	Vertical Spread
Field (10%)	95.8%	18,919.3	134.7	111.5
Beam (50%)	61.1%	12,060.3	117.9	45.1
Total	100%	19,750.3		

Tilt Angle– 45 Degree LLF–0.9

Mounting Height m (ft)	Maximum Point (fc)	Forward Throw Distance m (ft)			
		0.5fc/5lx m (ft)	1fc/11lx m (ft)	2fc/22lx m (ft)	5fc/54lx m (ft)
9 (30)	3.26	19 (63)	16 (54)	14 (45)	8 (27)
12 (40)	1.78	22 (72)	19 (62)	13 (42)	—
15 (50)	1.16	24 (80)	19 (62)	11 (35)	—
18 (60)	0.81	27 (90)	18 (60)	—	—

Side-to-Side Distance

Mounting Height m (ft)	0.5fc/5lx m (ft)	1fc/11lx m (ft)	2fc/22lx m (ft)	5fc/54lx m (ft)
9 (30)	37 (120)	27 (90)	21 (70)	8 (25)
12 (40)	40 (130)	30 (100)	18 (60)	—
15 (50)	43 (140)	27 (90)	6 (20)	—
18 (60)	43 (140)	24 (80)	—	—

Areamaster™ Generation 2 HL LED Luminaire

Floodlight for Hazardous Locations

NEC/CEC:

Class I, Division 2, Groups A, B, C, D
 Class I, Zone 2 Group IIC
 Class II, Division 1 and 2, Groups E, F, G
 Class III
 Zone 20 and 21 Group IIIC

NEC/CEC:

Zone 22, Group IIIB
 Simultaneous Exposure
 Marine Outside Type (Salt Water) for USA ONLY
 Wet Locations
 Type 3R, 4, 4X, IP66/67

ATEX/IECEX:

Zone 2, 22
 IP66
 II 3GD
 IK10
 Ex ec IIC T4

Photometric Data – DATA SHOWN IS ABSOLUTE

NEMA 7x6 Clear Glass

REPORT NUMBER: **AMLHL2CG7BU**

Luminaire Lumens 28,063

POLAR CANDELA DISTRIBUTION

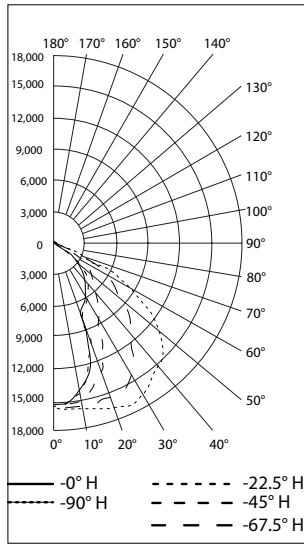

ISOFOOT CANDLE PLOT AT 45°

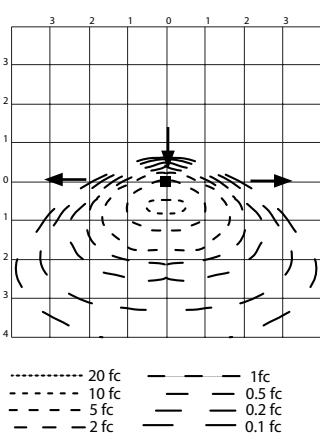

FLOOD SUMMARY

	Efficiency	Lumens	Horizontal Spread	Vertical Spread
Field (10%)	95.8%	26,888.8	134.1	111.1
Beam (50%)	61.5%	17,260.6	118.6	45
Total	100%	28,058.5		

Tilt Angle – 45 Degree LLF-0.9

Mounting Height m (ft)	Maximum Point (fc)	Forward Throw Distance			
		0.5fc/5lx m (ft)	1fc/11lx m (ft)	2fc/22lx m (ft)	5fc/54lx m (ft)
9 (30)	4.49	21 (68)	18 (60)	15 (48)	10 (32)
12 (40)	2.57	24 (80)	22 (72)	16 (52)	—
15 (50)	1.64	27 (90)	23 (75)	15 (50)	—
18 (60)	1.14	29 (96)	23 (75)	13 (42)	—

Side-to-Side Distance

Mounting Height m (ft)	0.5fc/5lx m (ft)	1fc/11lx m (ft)	2fc/22lx m (ft)	5fc/54lx m (ft)
9 (30)	41 (135)	35 (114)	24 (78)	15 (48)
12 (40)	46 (152)	37 (120)	24 (80)	—
15 (50)	49 (160)	37 (120)	23 (75)	—
18 (60)	48 (156)	33 (108)	9 (30)	—

NEMA 7x6 Clear Glass

REPORT NUMBER: **AMLHL2WG7BU**

Luminaire Lumens 23,532

POLAR CANDELA DISTRIBUTION

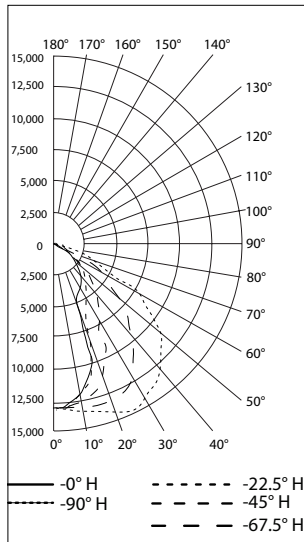

ISOFOOT CANDLE PLOT AT 45°

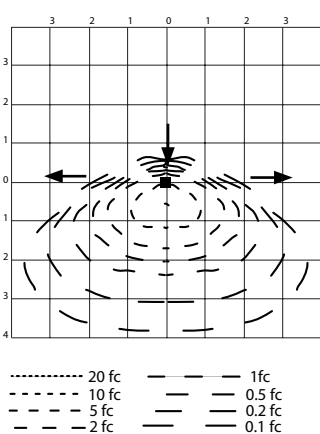

FLOOD SUMMARY

	Efficiency	Lumens	Horizontal Spread	Vertical Spread
Field (10%)	95.7%	22,530.7	134.6	111
Beam (50%)	60.9%	14,337.3	117.9	44.7
Total	100%	23,528.4		

Tilt Angle – 45 Degree LLF-0.9

Mounting Height m (ft)	Maximum Point (fc)	Forward Throw Distance			
		0.5fc/5lx m (ft)	1fc/11lx m (ft)	2fc/22lx m (ft)	5fc/54lx m (ft)
9 (30)	3.80	20 (66)	17 (57)	14 (45)	10 (32)
12 (40)	2.17	23 (76)	18 (60)	15 (48)	—
15 (50)	1.39	26 (85)	21 (70)	14 (45)	—
18 (60)	0.97	27 (90)	20 (66)	—	—

Side-to-Side Distance

Mounting Height m (ft)	0.5fc/5lx m (ft)	1fc/11lx m (ft)	2fc/22lx m (ft)	5fc/54lx m (ft)
9 (30)	38 (126)	33 (108)	22 (72)	13 (42)
12 (40)	44 (144)	34 (112)	22 (72)	—
15 (50)	46 (150)	30 (100)	18 (60)	—
18 (60)	48 (156)	29 (96)	—	—

Areamaster™ Generation 2 HL LED Luminaire

Floodlight for Hazardous Locations

NEC/CEC:
 Class I, Division 2, Groups A, B, C, D
 Class I, Zone 2 Group IIC
 Class II, Division 1 and 2, Groups E, F, G
 Class III
 Zone 20 and 21 Group IIIC

NEC/CEC:
 Zone 22, Group IIIB
 Simultaneous Exposure
 Marine Outside Type (Salt Water) for USA ONLY
 Wet Locations
 Type 3R, 4, 4X, IP66/67

ATEX/IECEX:
 Zone 2, 22
 IP66
 II 3GD
 IK10
 Ex ec IIC T4

Photometric Data — DATA SHOWN IS ABSOLUTE

NEMA 7x6 Clear Glass

REPORT NUMBER: AMLHL3CG7BU

Luminaire Lumens 35,430

POLAR CANDELA DISTRIBUTION

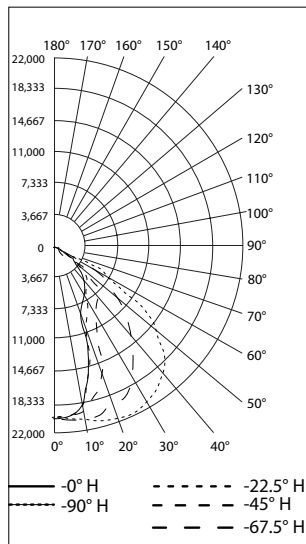

ISOFOOT CANDLE PLOT AT 45°

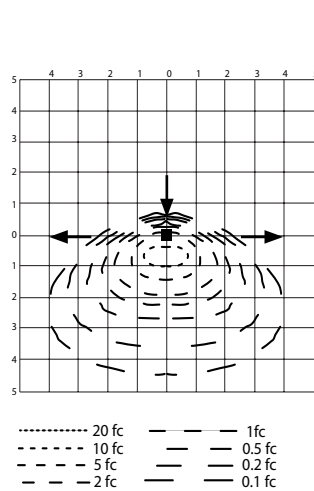

FLOOD SUMMARY

	Efficiency	Lumens	Horizontal Spread	Vertical Spread
Field (10%)	95.7%	33,908.8	139	111.1
Beam (50%)	60.9%	21,578.5	115.4	45.6
Total	100%	35,424.1		

Tilt Angle— 45 Degree LLF—0.9

Mounting Height m (ft)	Maximum Point (fc)	Forward Throw Distance			
		0.5fc/5lx m (ft)	1fc/11lx m (ft)	2fc/22lx m (ft)	5fc/54lx m (ft)
9 (30)	5.69	22 (72)	19 (62)	16 (54)	11 (36)
12 (40)	3.20	26 (84)	22 (72)	17 (56)	10 (32)
15 (50)	2.05	29 (95)	24 (80)	18 (60)	—
18 (60)	1.42	32 (105)	24 (78)	16 (54)	—

Side-to-Side Distance

Mounting Height m (ft)	0.5fc/5lx m (ft)	1fc/11lx m (ft)	2fc/22lx m (ft)	5fc/54lx m (ft)
9 (30)	42 (138)	37 (120)	27 (90)	18 (60)
12 (40)	49 (160)	37 (120)	27 (88)	12 (40)
15 (50)	55 (180)	40 (130)	27 (90)	—
18 (60)	55 (180)	40 (132)	22 (72)	—

NEMA 7x6 Clear Glass

REPORT NUMBER: AMLHL3WG7BU

Luminaire Lumens 30,346

POLAR CANDELA DISTRIBUTION

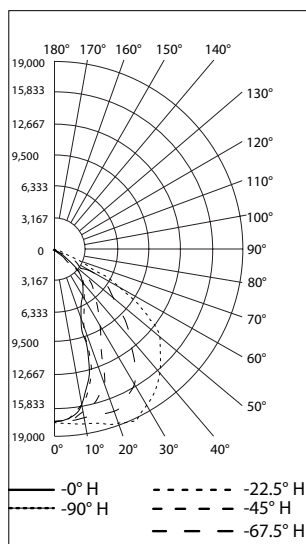

ISOFOOT CANDLE PLOT AT 45°

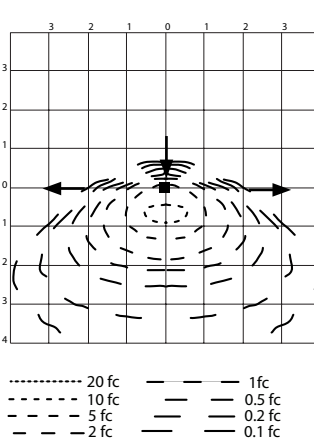

FLOOD SUMMARY

	Efficiency	Lumens	Horizontal Spread	Vertical Spread
Field (10%)	95%	31,186.0	96.1	93.5
Beam (50%)	84%	27,593.2	80.4	79.8
Total	100%	32,832.0		

Tilt Angle— 45 Degree LLF—0.9

Mounting Height m (ft)	Maximum Point (fc)	Forward Throw Distance			
		0.5fc/5lx m (ft)	1fc/11lx m (ft)	2fc/22lx m (ft)	5fc/54lx m (ft)
9 (30)	4.99	21 (69)	18 (60)	16 (54)	10 (33)
12 (40)	2.81	25 (82)	22 (72)	16 (52)	9 (28)
15 (50)	1.79	27 (90)	23 (75)	17 (55)	—
18 (60)	1.25	29 (96)	23 (75)	15 (48)	—

Side-to-Side Distance

Mounting Height m (ft)	0.5fc/5lx m (ft)	1fc/11lx m (ft)	2fc/22lx m (ft)	5fc/54lx m (ft)
9 (30)	41 (135)	35 (114)	26 (84)	16 (54)
12 (40)	49 (160)	37 (120)	24 (80)	2 (8)
15 (50)	49 (160)	37 (120)	23 (75)	—
18 (60)	51 (168)	37 (120)	18 (60)	—

Areamaster™ Generation 2 HL LED Luminaire

Floodlight for Hazardous Locations

NEC/CEC:

Class I, Division 2, Groups A, B, C, D
 Class I, Zone 2 Group IIC
 Class II, Division 1 and 2, Groups E, F, G
 Class III
 Zone 20 and 21 Group IIIC

NEC/CEC:

Zone 22, Group IIIB
 Simultaneous Exposure
 Marine Outside Type (Salt Water) for USA ONLY
 Wet Locations
 Type 3R, 4, 4X, IP66/67

ATEX/IECEX:

Zone 2, 22
 IP66
 II 3GD
 IK10
 Ex ec IIC T4

Photometric Data – DATA SHOWN IS ABSOLUTE

NEMA 7x7 Diffused Glass

REPORT NUMBER: **AMLHL1CF6BU**

Luminaire Lumens 20,578

POLAR CANDELA DISTRIBUTION

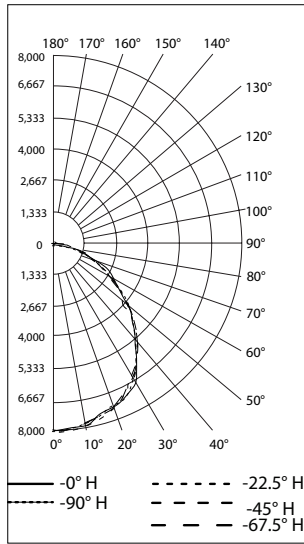

ISOFOOT CANDLE PLOT AT 45°

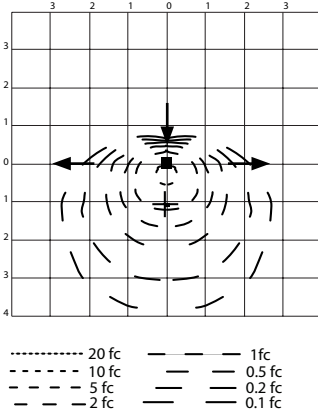

FLOOD SUMMARY

	Efficiency	Lumens	Horizontal Spread	Vertical Spread
Field (10%)	98%	20,176.5	155.7	154.5
Beam (50%)	70.2%	14,453.8	104.6	103.6
Total	100%	20,571.8		

Tilt Angle– 45 Degree LLF–0.9

Mounting Height m (ft)	Maximum Point (fc)	Forward Throw Distance			
		0.5fc/5lx m (ft)	1fc/11lx m (ft)	2fc/22lx m (ft)	5fc/54lx m (ft)
9 (30)	2.47	20 (66)	16 (54)	11 (36)	4 (12)
12 (40)	1.40	22 (72)	16 (52)	10 (32)	—
15 (50)	0.89	21 (70)	15 (50)	6 (20)	—
18 (60)	0.62	22 (72)	13 (42)	—	—

Side-to-Side Distance

Mounting Height m (ft)	0.5fc/5lx m (ft)	1fc/11lx m (ft)	2fc/22lx m (ft)	5fc/54lx m (ft)
9 (30)	31 (102)	22 (72)	16 (54)	4 (12)
12 (40)	32 (104)	22 (72)	12 (40)	—
15 (50)	30 (100)	21 (70)	5 (15)	—
18 (60)	33 (108)	15 (48)	—	—

NEMA 7x7 Clear Glass

REPORT NUMBER: **AMLHL1CG6BU rotated**

Luminaire Lumens 23,457

POLAR CANDELA DISTRIBUTION

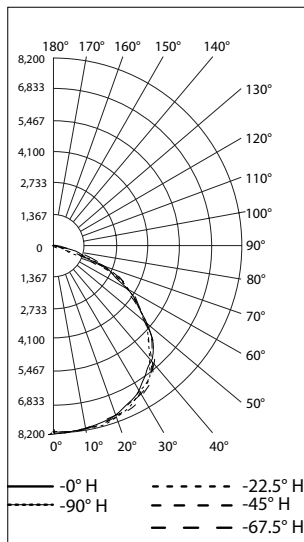

ISOFOOT CANDLE PLOT AT 45°

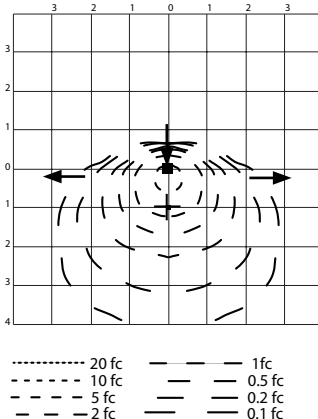

FLOOD SUMMARY

	Efficiency	Lumens	Horizontal Spread	Vertical Spread
Field (10%)	98.4%	23,090.9	151.1	151.2
Beam (50%)	80.3%	18,837.0	115.2	116.4
Total	100%	23,448.8		

Tilt Angle– 45 Degree LLF–0.9

Mounting Height m (ft)	Maximum Point (fc)	Forward Throw Distance m (ft)			
		0.5fc/5lx m (ft)	1fc/11lx m (ft)	2fc/22lx m (ft)	5fc/54lx m (ft)
9 (30)	2.84	20 (66)	16 (54)	11 (36)	5 (15)
12 (40)	1.60	22 (72)	17 (56)	10 (32)	—
15 (50)	1.03	23 (75)	15 (50)	6 (20)	—
18 (60)	0.71	23 (75)	14 (45)	—	—

Side-to-Side Distance m (ft)

Mounting Height m (ft)	0.5fc/5lx m (ft)	1fc/11lx m (ft)	2fc/22lx m (ft)	5fc/54lx m (ft)
9 (30)	33 (108)	24 (78)	18 (60)	7 (24)
12 (40)	34 (112)	24 (80)	15 (48)	—
15 (50)	37 (120)	24 (80)	12 (40)	—
18 (60)	35 (114)	18 (60)	—	—

Areamaster™ Generation 2 HL LED Luminaire

Floodlight for Hazardous Locations

NEC/CEC:
 Class I, Division 2, Groups A, B, C, D
 Class I, Zone 2 Group IIC
 Class II, Division 1 and 2, Groups E, F, G
 Class III
 Zone 20 and 21 Group IIIC

NEC/CEC:
 Zone 22, Group IIIB
 Simultaneous Exposure
 Marine Outside Type (Salt Water) for USA ONLY
 Wet Locations
 Type 3R, 4, 4X, IP66/67

ATEX/IECEX:
 Zone 2, 22
 IP66
 II 3GD
 IK10
 Ex ec IIC T4

Photometric Data — DATA SHOWN IS ABSOLUTE

NEMA 7x7 Diffused Glass

REPORT NUMBER: AMLHL2CF6BU

Luminaire Lumens 25,616

POLAR CANDELA DISTRIBUTION

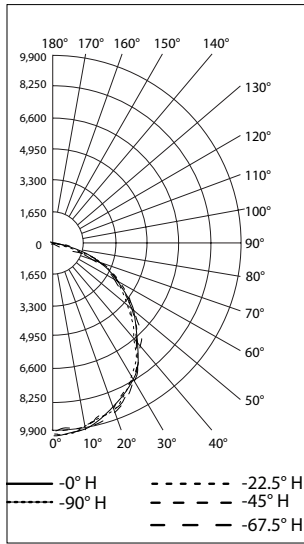

ISOFOOT CANDLE PLOT AT 45°

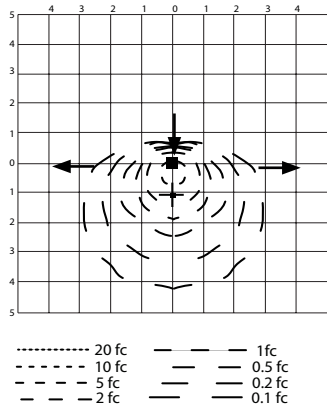

FLOOD SUMMARY

	Efficiency	Lumens	Horizontal Spread	Vertical Spread
Field (10%)	98.1%	25,135.5	155.9	154.5
Beam (50%)	69.9%	17,911.8	104.6	103.7
Total	100%	25,609.0		

Tilt Angle— 45 Degree LLF-0.9

Mounting Height m (ft)	Maximum Point (fc)	Forward Throw Distance			
		0.5fc/5lx m (ft)	1fc/11lx m (ft)	2fc/22lx m (ft)	5fc/54lx m (ft)
9 (30)	3.07	22 (72)	17 (57)	12 (39)	6 (21)
12 (40)	1.70	24 (80)	17 (56)	12 (40)	—
15 (50)	1.09	24 (80)	18 (60)	9 (30)	—
18 (60)	0.76	24 (78)	16 (54)	—	—

Side-to-Side Distance

Mounting Height m (ft)	0.5fc/5lx m (ft)	1fc/11lx m (ft)	2fc/22lx m (ft)	5fc/54lx m (ft)
9 (30)	33 (108)	24 (78)	18 (60)	7 (24)
12 (40)	34 (112)	24 (80)	17 (56)	—
15 (50)	37 (120)	24 (80)	15 (50)	—
18 (60)	37 (120)	18 (60)	—	—

NEMA 7x7 Clear Glass

REPORT NUMBER: AMLHL2CG6BU

Luminaire Lumens 30,157

POLAR CANDELA DISTRIBUTION

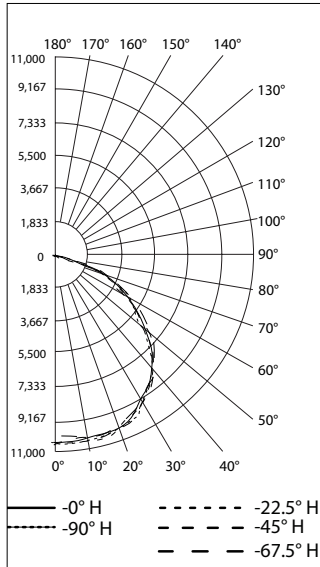

ISOFOOT CANDLE PLOT AT 45°

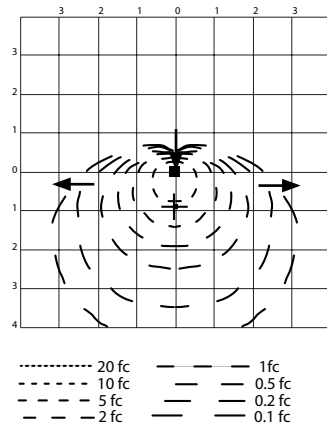

FLOOD SUMMARY

	Efficiency	Lumens	Horizontal Spread	Vertical Spread
Field (10%)	98.2%	29,616.7	151.4	145.9
Beam (50%)	81.2%	24,501.2	116.8	117.7
Total	100%	30,147.4		

Tilt Angle— 45 Degree LLF-0.9

Mounting Height m (ft)	Maximum Point (fc)	Forward Throw Distance			
		0.5fc/5lx m (ft)	1fc/11lx m (ft)	2fc/22lx m (ft)	5fc/54lx m (ft)
9 (30)	4.17	23 (75)	17 (57)	13 (42)	7 (24)
12 (40)	2.35	24 (80)	18 (60)	12 (40)	—
15 (50)	1.49	24 (80)	18 (60)	9 (30)	—
18 (60)	1.04	26 (84)	16 (54)	7 (24)	—

Side-to-Side Distance

Mounting Height m (ft)	0.5fc/5lx m (ft)	1fc/11lx m (ft)	2fc/22lx m (ft)	5fc/54lx m (ft)
9 (30)	35 (114)	26 (84)	19 (63)	9 (30)
12 (40)	37 (120)	27 (88)	20 (64)	—
15 (50)	37 (120)	24 (80)	15 (50)	—
18 (60)	37 (120)	22 (72)	9 (30)	—

Areamaster™ Generation 2 HL LED Luminaire

Floodlight for Hazardous Locations

NEC/CEC:

Class I, Division 2, Groups A, B, C, D
 Class I, Zone 2 Group IIC
 Class II, Division 1 and 2, Groups E, F, G
 Class III
 Zone 20 and 21 Group IIIC

NEC/CEC:

Zone 22, Group IIIB
 Simultaneous Exposure
 Marine Outside Type (Salt Water) for USA ONLY
 Wet Locations
 Type 3R, 4, 4X, IP66/67

ATEX/IECEX:

Zone 2, 22
 IP66
 II 3GD
 IK10
 Ex ec IIC T4

Photometric Data – DATA SHOWN IS ABSOLUTE

NEMA 7x7 Diffused Glass

REPORT NUMBER: **AMLHL3CF6BU rotated**

Luminaire Lumens 31,600

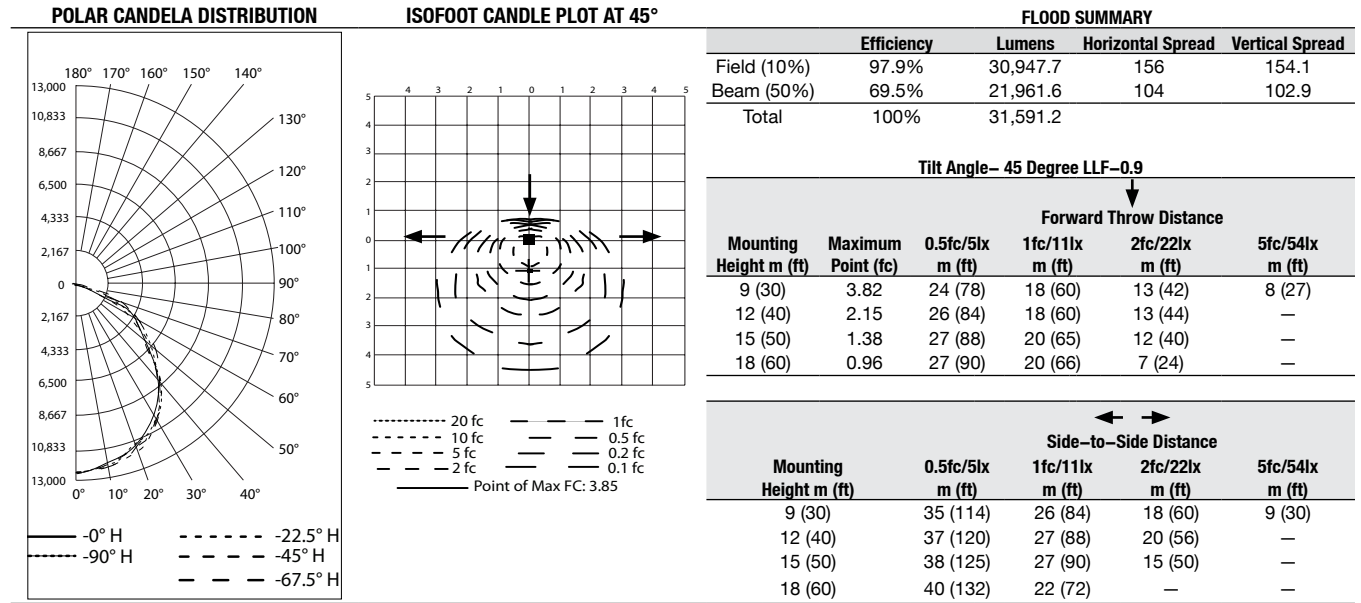

NEMA 7x7 Clear Glass

REPORT NUMBER: **AMLHL3CG6BU rotated**

Luminaire Lumens 37,039

